

HOME



WARRANTY \* INSTALLATION \* CARE

## QUICK CLICK



**Laminate Flooring**  
Radiant Heat Approved

# LIMITED RESIDENTIAL WARRANTY

## *Dream Home Laminate Products*

THIS LIMITED WARRANTY GIVES YOU SPECIFIC LEGAL RIGHTS, AND YOU MAY ALSO HAVE OTHER RIGHTS, WHICH VARY FROM STATE TO STATE.

THIS LIMITED WARRANTY CONTAINS ARBITRATION AND CLASS ACTION WAIVER PROVISIONS (SEE BELOW IN SECTION 9). THIS LIMITED WARRANTY ALSO CONTAINS LIMITATIONS OF LIABILITY (SEE BELOW IN SECTION 8).

WE LIMIT THE DURATION AND REMEDIES OF ALL IMPLIED WARRANTIES, INCLUDING, WITHOUT LIMITATION, THE WARRANTIES OF MERCHANTABILITY AND FITNESS FOR A PARTICULAR PURPOSE TO THE DURATION OF THIS EXPRESS LIMITED WARRANTY (SEE SECTION 2).

SOME STATES AND JURISDICTIONS DO NOT ALLOW LIMITATIONS ON HOW LONG AN IMPLIED WARRANTY LASTS, SO THE ABOVE LIMITATION MAY NOT APPLY TO YOU.

OUR RESPONSIBILITY FOR DEFECTIVE GOODS IS LIMITED TO THE STORE CREDIT AS DESCRIBED BELOW IN THIS LIMITED WARRANTY STATEMENT.

*[warranty information continues on following page]*

## **1. WHO MAY USE THIS LIMITED WARRANTY?**

LL Flooring, Inc. (“we,” “us,” and “our”) extends this limited warranty only to the consumer who originally purchased the product (“you” and “your”) and only for residential use. It does not extend to any subsequent owner or other transferee of the product. **THIS LIMITED WARRANTY IS NOT TRANSFERABLE. THE LIMITED WARRANTY EXTENDS ONLY TO THE ORIGINAL END-CONSUMER.** For purposes of this limited warranty, a “residential use” is a product installation at a single-family home, apartment unit, townhouse, or other place where people live and, notwithstanding the forgoing list, excludes: (a) multi-family housing common areas; (b) any real estate property that is used for business or commercial activities; (c) any location used in whole or in part for business or commercial purposes; and (d) any location where foot traffic exceeds normal, residential foot traffic. We have the sole right to make the determination of whether an application is a residential use or another kind of use. For purposes of such determination, we may need to visit the location that relates to the warranty claim for inspection and use. This limited warranty does not apply to any commercial or industrial use.

## **2. WHAT IS THE PERIOD OF COVERAGE?**

Subject to the requirements listed in Section 5 below, this limited warranty starts on the date of your purchase and lasts for the time period set forth in the chart below for your specific product (the “Limited Warranty Period”):

<b>Product Identification</b>	<b>Limited Warranty Period</b>
<b>Dream Home</b>	<b>30 Years</b>

If, for any reason, we repair or replace the product, the Limited Warranty Period is not extended. We may change the availability and duration of this limited warranty at our discretion, but any changes will not be retroactive.

Where the Limited Warranty Period noted above provides for a “Lifetime” warranty, the duration of this limited warranty shall be the lifetime of the original purchaser so for as long as they own the flooring.

## **3. WHAT DOES THIS LIMITED WARRANTY COVER?**

During the Limited Warranty Period (defined above) and subject to the complete terms of this limited warranty, this limited warranty covers the following product aspects from defects in materials and workmanship of the purchased product (the “product”):

- ***Limited Finish Wear Warranty.*** Finish wear from normal residential use conditions resulting in the exposure of the decorative layer, subject to the exclusions provided in Section 4 below.

- **Product Structure.** The product will be free of manufactured defects in materials and workmanship.
- **Light Fading.** The product will not fade due to sunlight or artificial light exposure under normal residential conditions of use.
- **Delamination.** The product will not delaminate under normal residential use conditions.

#### **4. WHAT DOES THIS LIMITED WARRANTY NOT COVER?**

This limited warranty does not cover any defects or damages due to: (a) failure to strictly follow the Installation and Care Requirements (defined and discussed below) regardless of the installer; (b) transportation; (c) storage; (d) improper use; (e) modifications; (f) unauthorized repair; or (g) external causes such as accidents, abuse, or other actions or events beyond our reasonable control. In addition, this limited warranty does not cover any defects or damages due to the following:

- **Moisture (or Lack of Moisture).** Damages caused by moisture (such as leaking pipes, spills, wet mopping, pets, relative humidity, subfloor moisture etc.) are excluded. Moisture (and dryness) can cause issues such as checks, cupping, crowning, warping, buckling, peeling, twisting, seam swelling or gapping. In addition, moisture intrusions from concrete hydrostatic pressure, flooding, or plumbing leaks, along with high levels of alkalinity, can affect flooring and subflooring over time and moisture can be trapped below the flooring and/or underlayment and create mildew or mold. Damage from such conditions, including to the floor and subfloor, is not covered under this limited warranty.
- **Moisture Protection.** This flooring should not be used to seal an existing floor from moisture. This flooring cannot prevent problems associated with, or caused by flooding, excessive moisture, existing moisture, or alkalis in the subfloor or conditions arising from hydrostatic pressure. To be abundantly clear, this limited warranty does not cover damage to surrounding structure, walls, subfloor, fixtures, furniture, underlayment, moldings, trims, subfloor heating elements, or anything that is not the product itself. This limited warranty does not cover damage resulting from mold and/or mildew growth due to prolonged exposure to moisture, all casualty events involving water coming in contact with your floor and failures normally covered by insurance, including, but not limited to, damages caused by flooding or standing water from leaky pipes, faucets, or household appliances.
- **Site and Environmental Conditions.** Defects or damages resulting from: site conditions (such as extreme heat, radiant heat (for some products), or exposure to sand); indentations and scratches (caused by furniture, heavy rolling loads like un-modified wheels on caster chairs, castor chairs without protection mats, heavy electric wheel chairs, metal or thin wheels on appliances, tools, grit, heels, toys, etc.); improper maintenance and accidents; misuse and abuse. These items are not covered under this limited warranty.

- *Gloss Reduction.* Fading or loss of gloss (or glaze) is not finish wear and not a product defect covered under this limited warranty.
- *Other Finishes.* This limited warranty covers the factory-applied finish only. Applying another finish or sanding (such as in preparation for another finish) voids this limited warranty against finish wear and may damage the factory applied finish.
- *Exterior or Indoor/Outdoor Use / Installation.* This limited warranty does not cover exterior or indoor/outdoor or full or partial exterior /outdoor use or installation of the product.
- *Non-Flooring Installations.* Except where the product’s Installation and Care Requirements designate the product as appropriate for wall installation, this limited warranty does not cover use of the products for installations on ceilings or other usages for purposes other than flooring (like furniture or countertops).
- *Visible Defects.* As discussed further below in Section 5.C., products installed with visible defects are not covered under this limited warranty. Accordingly, before installation, you and the installer should examine each product to ensure it is satisfactory.
- *Color and Shade Variations.* New or replacement flooring may not always match samples, printed color photography (including websites and catalogs), existing flooring or other products (such as cabinets, stair railings, trim and moldings). These variations should be expected. Inspect product before installation as claims for color and shade variation will not be accepted after the product is installed.
- *Discoloration/Fading from Mats.* This limited warranty does not cover discoloration due to use of rubber-backed mats or other incompatible mats.
- *Odd Lots or As-Is.* An odd lot is flooring that is discounted and sold “As-Is” because it did not pass our rigorous inspection process. As such, odd lot product is not covered by this limited warranty.
- *Third-Party Purchases.* This limited warranty does not cover any purchases other than those made directly from LL Flooring in store, online, or by phone.
- *Radiant Heat.* This limited warranty does not cover any products installed over radiant heat that are not installed according to the radiant heat manufacturer guidelines or not installed in compliance with the Installation and Care Requirements.
- *Removal and Replacement.* This limited warranty does not cover the cost of the removal or replacement of Countertops, cabinets, built-in appliances, or other fixtures, installed on top of your floor or that need to be moved and or altered to facilitate repair / replacement.
- *Improper Installation and Maintenance.* This limited warranty does not cover any dissatisfaction or damage due to improper installation or maintenance. This includes any

damages caused by any installation (regardless of the source of the installation advice) that conflicts with the applicable industry installation standards and product installation instructions—for example, damage caused by sub-surface, sub-flooring and jobsite environmental deficiencies, improper transportation, acclimation and storage.

## **5. HOW DO I MAINTAIN THIS LIMITED WARRANTY DURING THE WARRANTY PERIOD?**

To maintain this limited warranty during the Limited Warranty Period, you are obligated to meet all of the following requirements for your use, installation, and maintenance of the product (the “Installation and Care Requirements”). The Installation and Care Requirements must be strictly followed for the limited warranty to remain valid and not be void.

- A. *Follow the Pre-Installation Requirements.* Prior to installing a single board, tile, or product, you or the installer must determine that the job-site environment and the sub-surfaces (including subfloor substrates) meet or exceed applicable industry and product standards, including, without limitation, moisture testing and controls. The product installation instructions discuss these standards and are provided in full below. These requirements must be strictly followed.
- B. *Comply with All Laws.* In your installation, maintenance, and use of the product you must comply with all laws and regulations, including, without limitation, all applicable environmental and building codes, regulations, and laws.
- C. *Inspect All Products for Visible Defects.* Products installed with visible defects are not covered under this limited warranty. Accordingly, before installation, you and the installer should examine each product “unit” to ensure it is satisfactory. If any product units are unacceptable for any reason, it is up to you to determine to use them, trim off the imperfection, or not install them at all. You should plan on being present during your installation to ensure that all required procedures are completed and products with visible defects are not installed. In addition to inspecting individual boards and tiles frequently step back to observe the “whole picture” before installation is completed. *If quality issues are suspected before or during installation immediately contact the store where your floor was purchased or call us at 1-800-366-4204.*
- D. *Follow the Installation and Care Instructions.* It is your responsibility to ensure the installation requirements are strictly followed, including, without limitation, as they relate to the use of moisture barriers, installation tools, and the evaluation of job site conditions and moisture testing. The product installation and care manual(s) are provided in this document below, and those terms and provisions are part of this limited warranty.

## **6. WHAT ARE YOUR REMEDIES UNDER THIS LIMITED WARRANTY?**

With respect to any defective product during the Limited Warranty Period, we will provide a LL Flooring store credit in the amount of the purchase price paid for the defective portion of the flooring (excluding any installation costs and labor). A store credit is the sole remedy under this warranty and can be used for store product purchases only. Provided, however, we reserve the right, in our sole discretion, to repair or replace such product (or the defective part) free of charge in lieu of a store credit. We will also pay for shipping and handling fees to return the repaired or replacement product to you if we elect to repair or replace the defective product.

This limited warranty applies to the colors, designs and products available at the time of repair or replacement. If the original flooring is not available, LL Flooring will work with you to substitute a product of similar value. LL Flooring will always try to consider your needs.

We reserve the right to investigate, assess, and validate reported claims by, among other things, requesting samples from you for technical analysis and performing an inspection of the flooring and installation location.

## **7. HOW DO YOU OBTAIN WARRANTY SERVICE?**

To file a warranty claim during the Limited Warranty Period, you may:

- A. Visit the store where you purchased your floor;
- B. Call us at 1-800-366-4204; or
- C. Email via the “contact us” link at [www.llflooring.com](http://www.llflooring.com).

Claims must be submitted within the Limited Warranty Period and within ninety (90) days of the date that the problem with the floor is first discovered. No warranty claim will be serviced without contacting us through one of the methods listed above and any such claim must include you providing accurate and complete information in a timely manner.

## **8. WHAT ARE THE LIMITATIONS OF LIABILITY?**

**THE REMEDIES DESCRIBED ABOVE IN SECTION 6 ARE YOUR SOLE AND EXCLUSIVE REMEDIES AND OUR ENTIRE LIABILITY FOR ANY BREACH OF THIS LIMITED WARRANTY. NOTWITHSTANDING ANY OTHER PROVISION OR TERM, OUR LIABILITY SHALL UNDER NO CIRCUMSTANCES EXCEED THE ACTUAL AMOUNT PAID BY YOU FOR THE DEFECTIVE PRODUCT OR DEFECTIVE PORTION THEREOF.**

**UNDER NO CIRCUMSTANCES SHALL WE BE LIABLE FOR ANY CONSEQUENTIAL, INCIDENTAL, SPECIAL OR PUNITIVE DAMAGES OR LOSSES, WHETHER DIRECT OR INDIRECT. WITHOUT LIMITING THE FORGOING SENTENCE, LOSSES, DAMAGES OR EXPENSES RELATING TO ANYTHING OTHER THAN THE FLOOR ITSELF ARE NOT COVERED, INCLUDING, WITHOUT LIMITATION, MISSED TIME FROM WORK, HOTEL STAYS, STORAGE FEES,**

**KENNEL COSTS FOR PETS, REMOVAL OF DEFECTIVE FLOORING, INSTALLATION OF REPLACEMENT FLOORING, OR REMOVAL OR REPLACEMENT OF ITEMS BUILT ON TOP OF ANY FLOORING (FOR EXAMPLE, COUNTERTOPS, CABINETS, BUILT-IN APPLIANCES).**

**SOME STATES AND JURISDICTIONS DO NOT ALLOW THE EXCLUSION OR LIMITATION OF INCIDENTAL OR CONSEQUENTIAL DAMAGES, SO THE ABOVE LIMITATION OR EXCLUSION MAY NOT APPLY TO YOU.**

## **9. TERMS OF DISPUTE RESOLUTION**

**NO JOINT OR CLASS ACTIONS:** Neither you nor LL Flooring shall be entitled to join or consolidate claims in arbitration by or against other customers of LL Flooring with respect to other accounts, bring mass, class action, or consolidated claims in arbitration or a court of competent jurisdiction, or arbitrate or litigate any claim as a representative or individual of a class or in a private attorney general capacity. The arbitrator may not consolidate more than one person's claims and may not otherwise preside over any form of a representative or class proceeding.

**ARBITRATION:** The following informal dispute resolution procedure is available to you if you believe that we have not performed our obligations under this limited warranty. You must use this informal procedure before pursuing any legal remedy in the courts.

LL Flooring and you agree to attempt to resolve any disputes amicably. If, after thirty (30) days we are unable to do so, then you and LL Flooring each agree that any claim or controversy of any sort relating to our agreement, the Products or these limited warranty terms shall be determined by arbitration in the nearest U.S. city to the LL Flooring store where you purchased the products, before one arbitrator. At the option of the first to commence an arbitration, the arbitration shall be administered either by JAMS pursuant to its Streamlined Arbitration Rules and Procedures, or by the American Arbitration Association pursuant to its Commercial Arbitration Rules. The arbitrator shall have no power to add to, delete from or modify these limited warranty terms. Each of us shall have the right to conduct discovery to which we would be entitled had the dispute been resolved in a state court of general jurisdiction in the state of the LL Flooring store where you purchased the products. Judgment on the arbitrator's award may be entered in any court having jurisdiction. This clause shall not preclude either party from seeking provisional remedies in aid of arbitration from a court of appropriate jurisdiction. The arbitrator may, as part of the award, allocate all or part of the costs of the arbitration, including the fees of the arbitrator and the reasonable attorneys' fees of the prevailing party. The arbitrator shall only have the authority to resolve individual disputes between you and LL Flooring. Notwithstanding the foregoing, in addition to our rights set forth above, we may initiate proceedings directly in the appropriate court located in the U.S. city nearest the LL Flooring store where you purchased the products in connection with any claim to collect amounts due and owing by you.

## **10. NO OTHER TERMS**

**SAMPLES, DESCRIPTIONS, AND OTHER INFORMATION CONCERNING THE PRODUCT CONTAINED IN CATALOGS, ADVERTISEMENTS, OR OTHER**



**PROMOTIONAL MATERIAL OR STATEMENTS MADE BY SALES REPRESENTATIVES OR DISTRIBUTORS ARE FOR GENERAL INFORMATIONAL PURPOSES ONLY AND ARE NOT BINDING UPON LL FLOORING. NO SALES REPRESENTATIVES, STORE MANAGERS, ACCOUNT REPRESENTATIVES, OR DISTRIBUTORS SHALL HAVE ANY AUTHORITY WHATSOEVER TO ESTABLISH, EXPAND OR OTHERWISE MODIFY LL FLOORING WARRANTIES INCLUDING THE TERMS OF THIS LIMITED WARRANTY. THIS LIMITED WARRANTY MAY NOT BE AMENDED EXCEPT THROUGH A WRITTEN AGREEMENT TITLED “AMENDMENT TO LIMITED WARRANTY” AND SIGNED BY AN AUTHORIZED OFFICER OF LL FLOORING, PROVIDED, HOWEVER, THAT LL FLOORING MAY GENERALLY MODIFY, CANCEL, UPDATE, OR OTHERWISE CHANGE ITS PROSPECTIVE WARRANTIES FOR FUTURE SALES AT ANY TIME AND FOR ANY REASON.**

## **11. OTHER PROVISIONS**

The section headings provided in this limited warranty are for convenience and informational reference only and shall not affect the interpretation or construction of this limited warranty.

THE PROVISIONS OF THIS LIMITED WARRANTY ARE DEEMED TO BE SEVERABLE AND THE INVALIDITY OR UNENFORCEABILITY OF ONE PROVISION OR ANY PART THEREOF SHALL NOT AFFECT THE VALIDITY OR ENFORCEABILITY OF ANY OTHER PROVISION, ALL OF WHICH SHALL REMAIN BINDING AND ENFORCEABLE TO FULL EXTENT PERMITTED BY LAW.

## **12. ADDRESS FOR LL FLOORING**

LL Flooring, Inc. is located at 4901 Bakers Mill Lane, Richmond, VA 23230.



[HOME \\* INSTALLATION \\* CARE](#)

# QUICK CLICK \*

[WALL APPLICATION](#)

[Click Here](#)

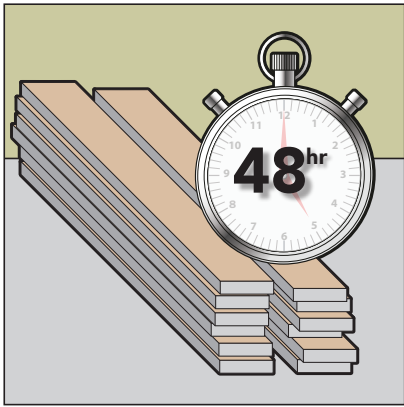
**Save time & avoid frustration! Please read these entire instructions before starting your installation, and A.I.M. for success!**

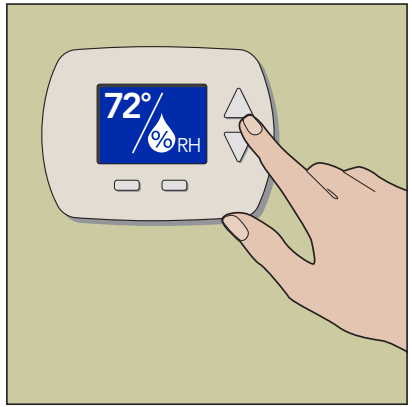
<p><b>AIM</b></p>	<p><b>AIM</b></p>	<p><b>AIM</b></p>
		
<p><b>Acclimate Completely</b></p> <p>Acclimate your flooring to interior temperature for at least 48 hours. Temp. must be between 50°F – 85°F.</p>	<p><b>Install Correctly</b></p> <p>Take time to review LL Flooring's installation guidelines to ensure that your installation goes well from beginning to end.</p>	<p><b>Maintain Environment</b></p> <p>Interior temperature should be maintained between 50°F – 85°F and 40% – 75% Relative Humidity during the life of the floor.</p>



**Need Help?** To obtain installation assistance or product information concerning this flooring, contact the store of original purchase, or call the LL Flooring's customer care at 800-366-4204.



**WARNING! DO NOT SAND, DRY SWEEP, DRY SCRAPE, DRILL, SAW, BEADBLAST OR MECHANICALLY CHIP OR PULVERIZE EXISTING RESILIENT FLOORING, BACKING, LINING FELT, ASPHALTIC "CUTBACK" ADHESIVES OR OTHER ADHESIVES.**

These products may contain asbestos fibers and/or crystalline silica. Avoid creating dust. Inhalation of such dust is a cancer and respiratory tract hazard. Smoking by individuals exposed to asbestos fibers greatly increases the risk of serious bodily harm. Unless positively certain that the product to be removed is a non-asbestos containing material, you must presume it contains asbestos. Regulations may require that the material be tested to determine asbestos content. See current edition of the Resilient Floor Covering Institute (RFCI) publication, "Recommended Work Practices for Removal of Resilient Floor Coverings" for detailed information and instructions on removing all resilient covering structures. For current information, go to [www.rfci.com](http://www.rfci.com).



**LEAD WARNING:** Some paints and finishes in homes built before 1978 may contain lead. Exposure to excessive amounts of lead dust presents a health hazard. Prior to removing or sanding, comply with all applicable federal, state, and local laws, and reference the publication "Lead-Based Paint: Guidelines for Hazard Identification and Abatement in Public and Indian Housing" available from the United States Department of Housing and Urban Development regarding (1) appropriate methods for identifying lead-based paint and removing such paint; and (2) any licensing, certification, and training requirements for persons performing lead abatement work.



**MOLD AND MILDEW WARNING:** Prior to removing an existing resilient floor or when installing a new floor, if there are visible indications of mold or mildew or the presence of a strong musty odor in the installation area, the source of the problem should be identified and corrected before proceeding with the flooring work. Excessive moisture in the subfloor could promote mold, mildew, and other moisture related issues like the trapping of moisture emissions under the flooring, which may contribute to an unhealthy indoor environment. Mold has the potential to cause health problems and may produce allergens, irritants, and in some cases, potentially toxic substances. Before installing the new resilient flooring, ensure the underlayment and/or subfloor is allowed to thoroughly dry and that any residual effect of excessive moisture, mold, or structural damage has been corrected. Remediation measures may require structural repairs such as replacing the contaminated underlayment and/or subfloor, cleanup measures using appropriate protection and biocide, or hiring a professional mold and mildew remediation contractor. Consult EPA mold guidelines on EPA's website at <https://www.epa.gov/mold>



**WARNING:**

Drilling, sawing, sanding or machining wood products can expose you to wood dust, a substance known to the State of California to cause cancer. Avoid inhaling wood dust or use a dust mask or other safeguards for personal protection. For more information go to [www.P65Warnings.ca.gov/wood](http://www.P65Warnings.ca.gov/wood)

## RECOMMENDED USE:

- Residential interior use only. See the product's limited warranty for details.
- **Do not install in wet areas like patios and showers, or exterior areas. Do not install in boats, or other moving vehicles.**

## GRADE:

On, above and below grade.

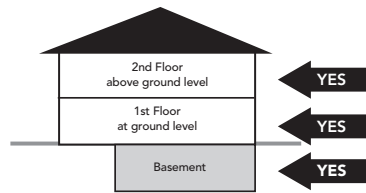

## JOBSITE CONDITIONS:

- The building should be enclosed with all doors and windows in place.
- Prior to delivery and install: All wet works (e.g. drywall taping, texture, painting, stucco etc.) should be complete and allowed to dry. The rooms should be at normal "lived-in" conditions with HVAC operational for at least one week prior to the installation when building is so equipped.
- When installing over basements and garages, ensure they are dry and well ventilated.
- Crawlspace must be dry with a minimum 18" from the bottom of the floor joist to the ground, Crawl space earth (or thin concrete slab) should be covered 100 percent by a vapor retarder of black polyethylene (minimum 6 mil) or any recommended puncture-resistant membrane, such as Class C, meeting ASTM D1745. Ventilation shall be per local building codes.
- All gutters should be in place and functioning properly. Yard grading should be sloped to run water away from the home's foundation.
- Ensure that exterior doors and appliances have sufficient clearance to accommodate the new flooring.
- Do not undercut metal door jambs before first confirming it doesn't violate local building and fire codes.
- To avoid damages to the floor's finish, all construction activity should be completed before installing this floor.
- The installer – not the manufacturer or retailer – is responsible for making sure that the site conditions are appropriate prior to installation of this floor.

## USER / OWNER / INSTALLER RESPONSIBILITIES:

- Install in good lighting.
- Product installation constitutes acceptance. Visually inspect the product and determine acceptability before installation. Claims will not be accepted regarding visual defects after flooring has been installed. If any planks are unacceptable due to color, finish, milling or any other reason, it is your responsibility to determine to use them, hide them in areas like closets, trim off the imperfection, or not install them at all.
- A reasonable amount of installed flooring (up to 25% or 100 sq. ft. whichever is less) is enough to determine acceptance of quality.
- Retain a box label and keep on file with your receipt for future reference.
- If quality issues are suspected stop the installation and call your local store or CUSTOMER CARE at 1-800-366-4204.

## HELPFUL TOOLS: (as needed)

- Tape Measure • Pencil • Chalk line • 6' level • Framing square/Metal straight edge • Screed • Utility knife (blades)
- Miter saw • Table saw • 60 tooth carbide tip saw blades • Jamb saw • Drill • Drill bit set • Hammer • Flat pry bar
- Broom • Eye protection • Ear protection • Knee pads • Niosh dust mask • Gloves • Hygrometer (to measure /monitor in-home humidity) • Moisture meter • Color putty • Touch up markers • Speed square

## ACCLIMATION:

### 48 hours

Stack unopened boxes flat, and no more than eight cartons high in areas to receive new flooring.

- Do not remove plastic wrapping from the packaging until ready to install the floor.

## TEMPERATURE:

For best product performance, ensure the temperature in the home is between 50° and 85F° before, during, and for the life of the flooring.

## RELATIVE HUMIDITY:

For best product performance, maintain Relative Humidity (RH) between 40% and 75% before, during, and for the life of the flooring.

## CUTTING ALLOWANCE:

A 10' x 10' room has net 100 square feet (Sq. Ft.) the actual area that will have flooring, but more product is required to allow for cutting which generates unusable pieces.

Carefully measure the net square feet required, adding up multiple areas.

The following table gives an approximate recommendation for cutting allowance:

**The table gives approximate recommendation for cutting allowance:**

Quantities are always rounded up to the nearest box.

**Tip:** If more than half a box is not available for spares we recommend ordering an extra box.

**Please note:** Actual cutting waste may be lower or higher based on room layout. E.g. multiple rooms vs. one large area and "pattern" being installed. E.g. diagonal installations will require more cutting allowance.

Consider carefully before returning boxes.

Keeping extra boxes is a great idea and inexpensive insurance against damage, if a repair is needed the product and batch will be the same, and you have options even if the product has been discontinued.

Diagonal installations will generally require 5% more material over and above the cutting allowance given above.

Net Area SqFt	Total with Cutting Allowance SqFt	% Applied
100	110	10
200	218	9
400	432	8
600	642	7
800	848	6
1000	1050	5
above 1000 SqFt add 5%		

**EXPANSION AND CONTRACTION SPACE:**

Allow 1/2" gap between the flooring and all vertical obstructions (walls, door jams, pipes, staircases, posts, fixtures, built-ins, etc.) to ensure floor trim covers expansion gap and allows for 1/2" contraction by overlapping the flooring (see How to Achieve space for expansion and contraction Installation). If the room has electric baseboard heaters, leave a minimum of 3/4" between the surface of the flooring and the bottom of the heaters, allowing heat to circulate properly.

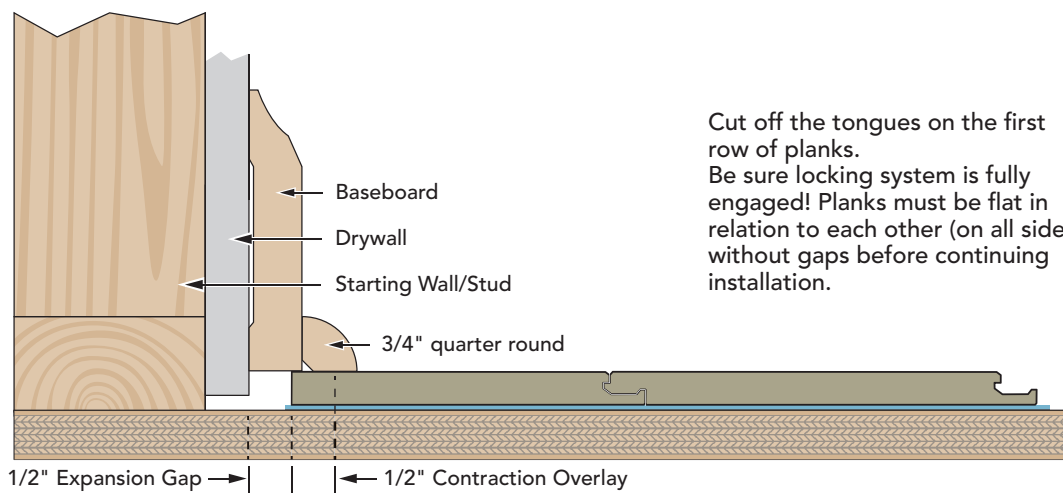
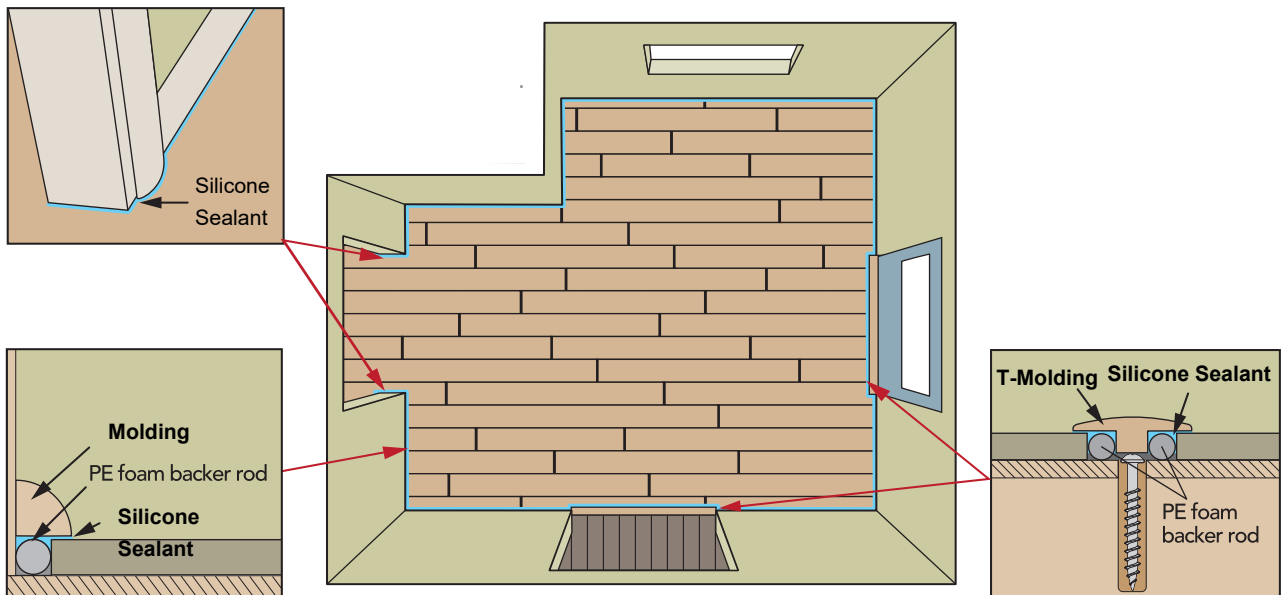

Cut off the tongues on the first row of planks. Be sure locking system is fully engaged! Planks must be flat in relation to each other (on all sides) without gaps before continuing installation.

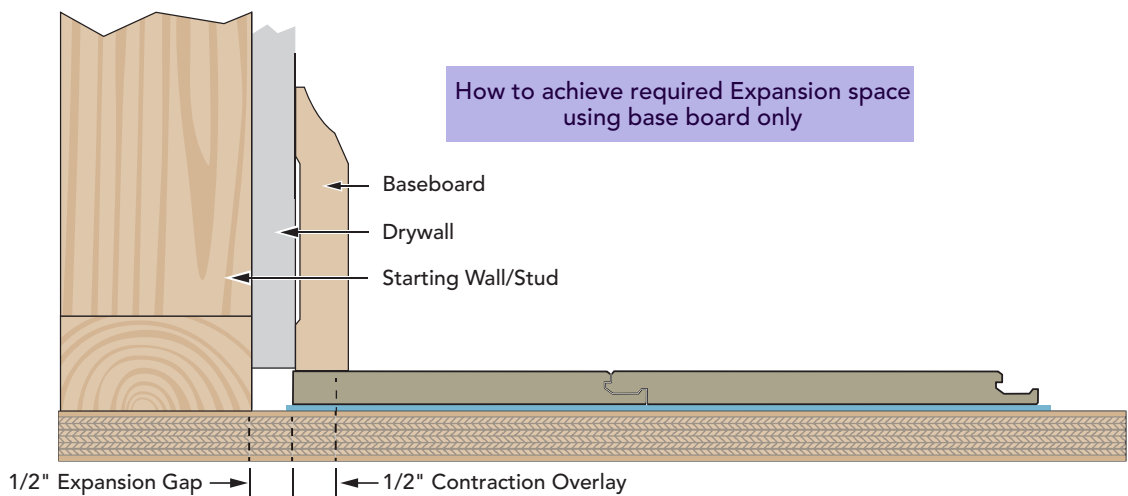

### RUN WIDTH AND LENGTH:

T-moldings must be used in the middle of rooms longer than 40 feet (in the direction of plank length) or 40 feet (in the direction of plank width) to allow for normal contraction and expansion of the floor.

**NOTE:** This flooring is installed as a floating floor and as such cannot be glued, nailed, screwed or otherwise fixed or attached (e.g. door stopper, closet track, stair rails, etc.) to the subfloor in any way. It must have room to expand and contract freely. Gapping and buckling can develop if expansion space and t-moldings, requirements are not followed.

### CABINETS / FIXED FIXTURES:

Do not install under fixed cabinets or islands of any type.

### SUBFLOORS NEED TO BE: CLEAN – FLAT – DRY:

Wood substrates must be structurally sound and free from movement or deflection

### CLEAN:

Free from particles including but not limited to: dust, dirt, and grit.

### SUBFLOOR MUST BE FLAT AND SMOOTH

### FLAT:

Subfloors must be flat within 1/8" over 6' and 3/16" over 10' and smooth, abrupt peaks and valleys must be avoided.

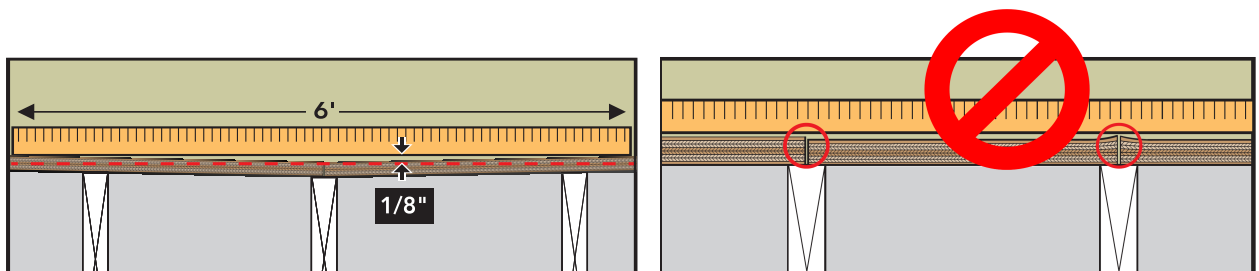

- Improper substrate or flatness can result in gaps, squeaks, premature wear on surface and poor plank fitting during assembly.  
**Correct any issues.**

### DRY:

See Moisture Testing requirements below.

Do not install this flooring over plywood underlayment attached to concrete, unless it is known that an appropriate moisture barrier has been installed (all applications).

## WOOD SUBFLOOR PREPARATION:

- Screw down loose or squeaky sections of plywood and replace areas that are damaged.
- To address flatness concerns sand or plane high spots, 15 – 30 lb. roofing felt can be used to build up (in layers) low areas on wood subfloors.
- Substrates that are un-level due to structural deficiencies should be repaired by a licensed contractor.
- **Never apply plastic sheet over wood subfloors.**

## STRUCTURAL REQUIREMENTS:

Note that joist spacing determines minimum subfloor thickness.

### Joist spacing 16" on center (OC) or less

– Plywood: Minimum of (5/8", 19/32") Oriented Strand Board (OSB): minimum (3/4", 23/32")

- Improper substrate or flatness can result in gaps, locking mechanism failure and premature wear on surface  
Advantech minimum (3/4", 23/32")

### Joist spacing 16" up to 19.2" (OC)

– Plywood: Minimum of (3/4", 23/32") Oriented Strand Board (OSB): minimum of (3/4", 23/32")

### Joist spacing over 19.2" up to maximum 24" (OC)

– Plywood: Minimum of (7/8") Oriented Strand Board (OSB): Minimum of (1") or two layers of subflooring or brace between truss/joists in accordance with local building codes.

## MOISTURE TESTING:

Use a meter that is species / material adjustable. E.g. Ligno-scanner SDM moisture meter.

- If using alternate meter check with manufacturer that meter is species adjustable.

Test sub-floor in multiple locations, with an appropriate wood moisture meter, it's recommended to test 20 location per 1000 square feet and average the results. Moisture readings must not exceed 12%.

- Higher readings indicate a moisture concern that needs to be addressed before installation can begin.
- For your protection, documenting and saving the test results is recommended.

Do not install this flooring over plywood underlayment attached to concrete, unless it is known that an appropriate moisture barrier has been installed.

## SUBFLOORS NEED TO BE: CLEAN – FLAT – DRY:

Concrete substrates must be structurally sound and free from movement or deflection.

### CLEAN:

Free from particles including but not limited to: dust, dirt, and grit.

### SUBFLOOR MUST BE FLAT AND SMOOTH

### FLAT:

Subfloors must be flat within 1/8" over 6' and 3/16" over 10' and smooth, abrupt peaks and valleys must be avoided.

Improper substrate or flatness can result in gaps, locking mechanism failure and premature wear on surface.

Correct any issues.

### DRY:

Do not install this flooring over plywood underlayment attached to concrete, unless it is known that an appropriate moisture barrier has been installed (all applications).

## CONCRETE SUBFLOOR PREPARATION:

- 6 mil polyethylene moisture barrier- seams overlapped 4"- 6" and taped using a waterproof adhesive tape (e.g. duct tape) must be used or LL underlayment with a water vapor permeance of 0.1 perm or less when tested in accordance with the ASTM E96.
- **Roll-Cote by Bostik**, a new roller applied moisture barrier alternative to 6 mil poly. Two coats of Roll-Cote must be applied to perform as a Moisture-Vapor-Barrier. Follow manufacturer's TDS / installation guide. [Click here for complete details](#)
- Do not proceed with installation if concrete is wet or shows sign of dampness. Excessive moisture could lead to mold / mildew. (Underlayment's with a vapor retarder still require this moisture barrier).
- To address flatness concerns; Grind down\* high spots and fill in low spots with an appropriate Portland cement based patch or self-leveler (allow to cure fully) prior to installing floor. \*CAUTION: Follow OSHA guidelines (29 CFR 1926.1153) regarding silica dust hazards.
- 15 / 30 lb. roofing felt or vinyl tile can be used to build up (in layers) low areas on concrete subfloors.

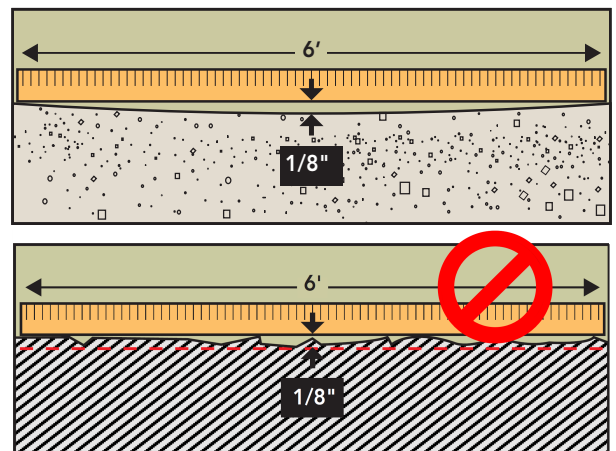

### LIGHTWEIGHT ALTERNATIVE SUBFLOORS:

- Installation over gypsum-based slabs is limited to above grade, floating installations only. Do not use 6mm poly over lightweight concrete e.g. Gypcrete use gypsum-based patch or self-leveler (allow to cure fully) prior to installing floor.
- \***CAUTION:** Follow OSHA guidelines (29 CFR 1926.1153) regarding silica dust hazards.

### EXISTING FLOORS:

- This flooring can be floated over existing clean, flat, dry, well bonded/secured tile, vinyl and wood flooring\*.
- \* **Do not install** over wood flooring installed over concrete unless it is known that an appropriate moisture barrier has been installed over the concrete.
- Do not install over cushioned vinyl flooring, or existing floating floor products.
- Do not install over carpet and padding.

### RECOMMENDED PATCHES/LEVELERS:

- Cement Patching- Bostik WebcreteR 95™
  - Total Surface Self-Leveling- Bostik SL-175™ (plus Primer Pro)
- Follow manufacturer's TDS / installation guide.

### RADIANT HEAT SYSTEMS:

This Dream Home flooring product may be installed over approved QuietWarmth film systems.

QuietWarmth comes in several sizes to configure to your individual space whether Large or small!

Call 1-800-366-4204 or see you local store for complete details.

[Please review manufacturer's technical data sheet for more details.](#)

- This flooring is suitable for installation over Hydronic Radiant heating systems provided that the heating element is not in direct contact with the product.
- New heating systems should be running two weeks before installation to remove residual moisture from the subfloor.
- Lower temperature of heating system to 60°F for one week prior to installation.
- Gradually increase temperature in increments of 10° per day to avoid "shock" to resilient flooring.
- Surface temperature should not exceed or sustain 85°F.

Because of the wide array of systems on the market each with its own features and applications, it is recommended that the user consult with the heating provider for best practices and installation methods.

It is the user's responsibility to confirm the suitability of any selected or existing radiant-heating system that will be used in conjunction with this flooring.

Rugs placed over radiant heated flooring can increase the surface temperature in that area by 3°- 5°F degrees.

### ADDITIONAL UNDERLAYMENT:

- Quality Underlayment is recommended. It can help smooth out minor subfloor imperfections, provide moisture protection over all subfloors and have added insulation and sound control properties.
- NOTE: Some acoustical "vapor retarder" underlayments have limits of moisture protection and are not a substitute for a 6 mil polyethylene moisture barrier. Underlayments that have a water vapor permeance of 0.1 perm rating or less when tested in accordance with ASTM E96 can be used in place of 6 mil poly sheeting.
- **We recommend the following underlayments to maintain your manufacturer's warranty and provide moisture protection of 0.1 perm rating or less:** [QuietWalk Max](#) (10056877), [QuietWalk Versa](#) (10056873) [QuietBoard](#) (10056807) and [EcoSilencer Max](#) (10056803).
- Be sure to follow manufactures installation guidelines to include additional waterproof tape as required.
- This flooring is waterproof, however, moisture intrusions from concrete via hydrostatic pressure, flooding, or plumbing leaks, along with high levels of alkalinity, can affect floor coverings over time.
- Moisture can also be trapped below the flooring and create mildew or mold
- LL offers a wide variety of underlayments, please call 1-800-366-4204 or see your local store for recommendations

### ADDITIONAL NOTES:

When moving furniture and heavy equipment, use luan board, plywood, or other similar covering to protect the floor.

**Each project is unique and different. Installation advice or recommendations are given as a courtesy and not intended to take the place of an installer's visual inspection, expertise or informed judgment, the end user / contractor on-site is ultimately responsible for ensuring that selected products are appropriate for local conditions and / or their final use of the product.**



**RADIANT HEAT FILM FOR FLOATING FLOORS**

# How to Assemble Quick Click Flooring

Tongue →  ← Groove

**PROFILE (END VIEW)**



1. Insert tongue into groove at approx. 30° angle.

2. Push down while applying forward pressure to fully engage planks.

**THIS PRODUCT HAS A UNIQUE FOLD-DOWN END JOINT LOCKING SYSTEM!**  
Apply downward force with thumbs to connect the two planks together to engage into position until you hear it "click" into place.  
To avoid installation damage: Do not use excessive force to engage the locking mechanism!

Cut off the tongues on the first row of planks. Be sure locking system is fully engaged! Planks must be flat in relation to each other (on all sides) without gaps before continuing installation.

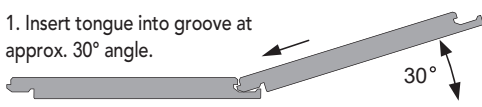
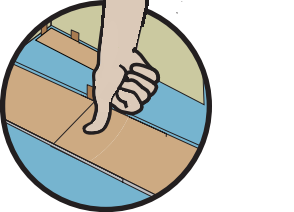
**NEVER USE A TAPPING BLOCK OR PULL BAR. THESE WILL DAMAGE YOUR FLOORING AND VOID THE WARRANTY**





## GETTING STARTED:

Remove any existing quarter round, shoe moldings, baseboards and doorway transitions. Remove existing floor covering as required, check floor flatness per details on previous page and address any issues. Check that all doors will swing open with adequate clearance over the new flooring prior to starting any work.

**Important:** Do not cut metal door frames before first confirming it does not violate local building and fire codes. Any metal doors must be addressed by a specialist to adjust.

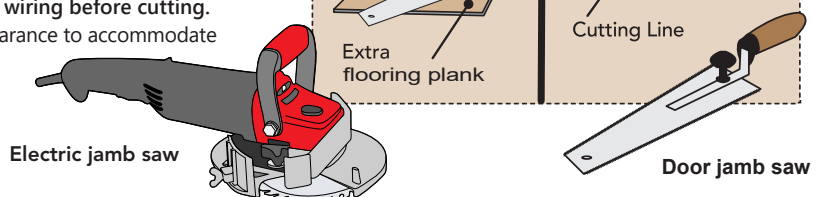
Undercut all door casings and jambs with a jamb saw to allow the flooring to slide under the doorjamb. If a baseboard is still in place, extend the undercut about 1" beyond the door frame casing. To find the height to cut the jamb, lay a scrap piece of flooring next to the door frame and lay the saw blade on top. After cut, ensure the floor plus underlayment does not bind, always leave 1/16" clearance under the door jamb / casing for the floor to be able to move freely without vertical restriction. **Check for alarm or other low voltage wiring before cutting.** Ensure that appliances have proper clearance to accommodate the new flooring.



**STEP 1:** Check that subfloor is flat to within specifications per details found under "CLEAN-DRY-FLAT" in previous section. **Correct any issues.**

### STEP 2:

Install 6 mil polyethylene film vapor barrier if subfloor is concrete or omit this step if an LL underlayment with a water vapor permeance of 0.1 perm or less when tested in accordance with the ASTM E96 is being used.

**Never install 6 mil poly over wood substrates!**

**NOTE:** Cushioned "vapor retarder" underlayments are not a substitute for a 6 mil polyethylene moisture barrier.

### STEP 3:

Install customer preferred cushion.

\*See "UNDERLAYMENT" section above for list approved underlayments.

Underlayment padding is *highly recommended* for laminates that do not come with a pre-attached cushion on the back of the plank.

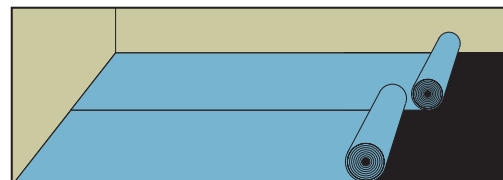
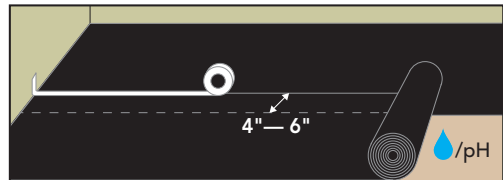
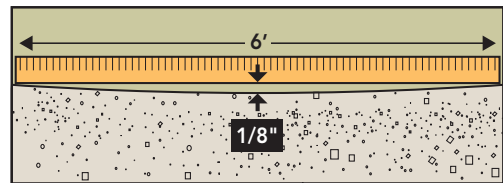



#### STEP 4. LAYOUT:

Determine which direction the planks will be installed. Generally, plank flooring is run parallel with the longest straight exterior wall, or the focal point of the room. Considerations are fireplaces, doors, cabinets, transitions.

For best appearance full planks are desirable at the focal point and most cases it is the longest unbroken wall in the room.

Determine which direction the planks will be installed.

*Installers: It is advisable to determine the installation layout and direction (North/South vs East/West) with the end user.*

**IMPORTANT:** Mix materials from several cartons to ensure best overall color/shade appearance of the installed floor.

 **Caution!** Prior to cutting planks lengthwise, remove the plastic locking clip by sliding it carefully out of the slot. After cutting the plank, cut the clip to fit and insert it back into the plank.

**Preparation of planks for the starting row when needed:** To avoid very narrow pieces at finish wall; measure the distance between the starting wall to the finish wall, then divide this number by the width of the flooring planks. The fraction is the width of the last plank.

**Eg. for a 10' room:**

Start – Finish = 120" – 1" (1/2" expansion x 2) = 119"

Width of Plank = 5"

$119 \div 5 = 23.8$

Twenty full planks are required and last will be fraction x plank width

$5" \times 0.8 = 4"$

If width of last plank is less than 2.5", balance by cutting (Rip) starting row of planks accordingly.

**NOTE:** If a narrow strip is unavoidable for the last row, the final two rows can be glued together at the joint using Exmore-PVA Tongue & Groove Adhesive at the long seams to avoid board separation.

#### STEP 5: ESTABLISH A WORKING LINE

In at least two places, measure out equal distance from your starting wall, 12"–18" from each corner.

The distance from the starter wall to the line will be the width of the plank used on first row, the expansion space. Mark these points and snap a chalk line (as shown) parallel to your starting wall. Be sure to maintain proper gap around all vertical obstructions, e.g. newel posts, raised hearths, upright pipes, etc.

#### STEP 6.

Use spacers to maintain the recommended expansion gap between the flooring and the walls. Place spacers adjacent to each plank joint and at the beginning and end of each row. This will lock-in assembled panels and prevent shifting during installation.

It is important to have your starting row perfectly straight and properly supported against your starting wall. Always allow a 1/2" gap around all other fixed

objects including upright pipes or other fixtures.

**Tip:** Scrap flooring (cut up in short strips) may be used for additional spacing material.

#### STEP 7. THE FIRST ROW

Starting row: Install planks from left to right, up against the spacers.

- Lay the first plank in the left-hand corner, up against the spacers, with the groove side facing toward you.
- Lay the second plank flat on the floor with the short edge joint aligned directly over the groove of the first plank.
- Apply downward force with thumbs to engage into position until you hear it "click" into place. Continue in this manner until the first row is complete.

**NOTE:** See STEP 10. for how to cut the last plank in row.

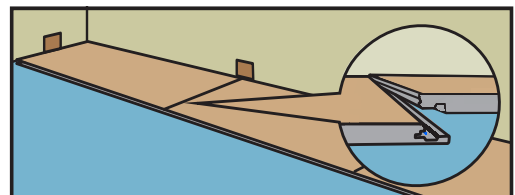
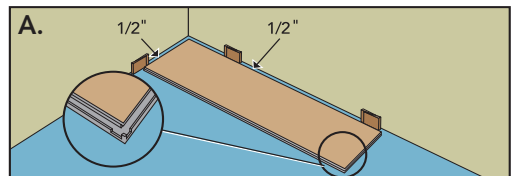
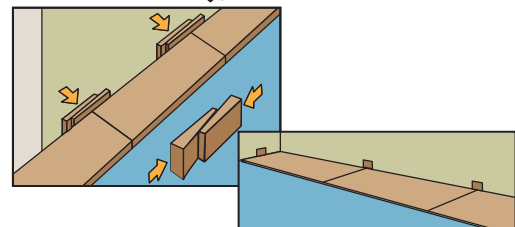
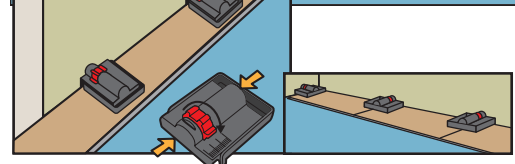
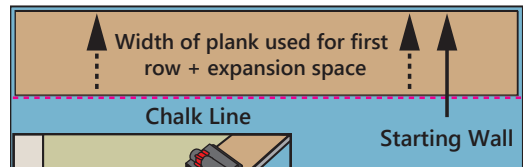
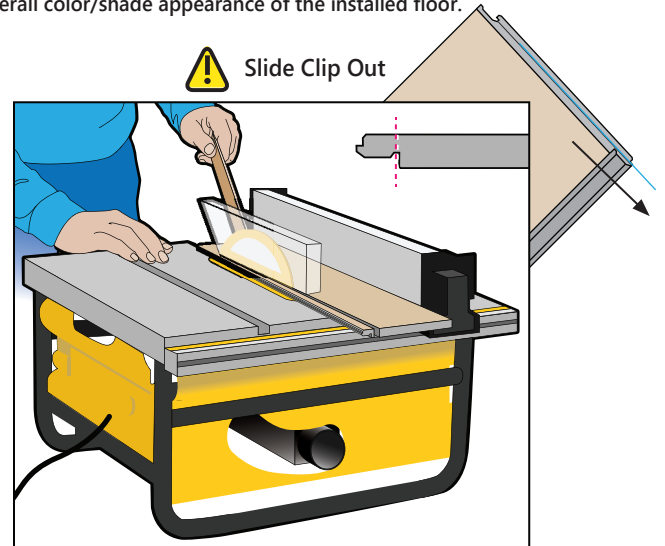

**Alternative method for FIRST ROW:**

- A. With planks flat on the floor, connect the second piece by laying it flat on the substrate (where the second row would be), lining up the “end” locking mechanism. Then, while keeping the joint perfectly in line, slide the locking mechanism together as shown.
- B. Be sure joint is even and flat. Continue with this method and complete the first row, including the last piece.  
*Only the first row of planks is assembled in this manner.*  
NOTE: See STEP 10. for how to cut the last plank in row.

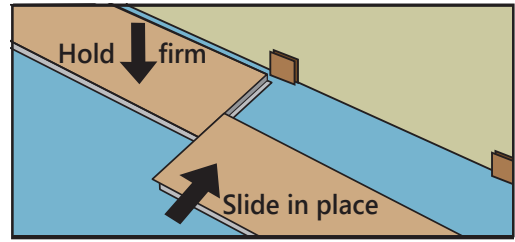

**STEP 8. SECOND & CONSECUTIVE ROWS**

Confirm the first row is straight with working line.

- A. Use a cut plank at least 8” in length, angle the tongue of the long side of the plank into the groove of the first plank of the first row at an angle of approx. 30° and while applying forward pressure, lower the plank down to lock it into place.
- B. Align and overlap end-joint of second plank, insert tongue at angle into groove of previous row and lower to the floor. Be sure the ends of the boards are in proper alignment, then firmly lower into position. (Be sure to engage end seams flat). Repeat this process with each plank until you reach the end of each row.

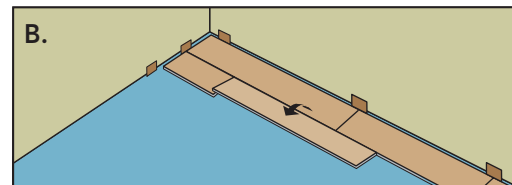
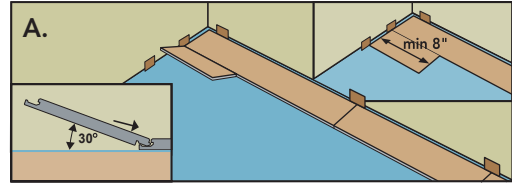

NOTE: Planks are designed to interlock easily and with a small amount of pressure; if this is not the case, inspect the connection system for damage or debris. Double check that plastic insert is fully seated into groove.

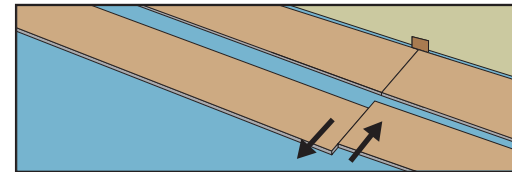
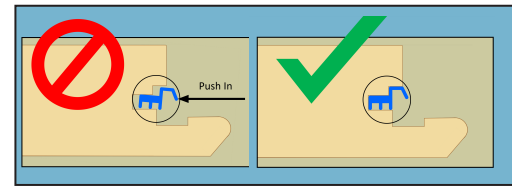

**STEP 9. IMPORTANT:**

When laying out planks, always stagger end joints from row to row, by at least 12” to ensure the structural integrity of your floor and a pleasing appearance. Work from different cartons of planks to minimize clustering of patterns. Pay close attention to avoid “stairstep” or “H-patterns” appearing in the flooring.

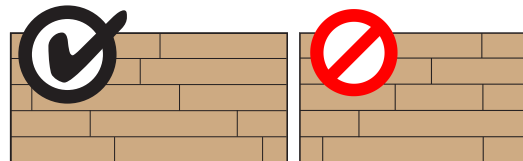

1. Flip the plank over, end-to-end.
2. Lay the flipped board next to the row of planks and mark it on the face.
3. Cut the plank at the mark.
4. Flip the plank back over and install as normal.

\* The last piece in each row should be at least 8”.  
\* The piece you cut off may be used as the first piece in the next row, if it meets the minimum length criteria for the pattern being installed.

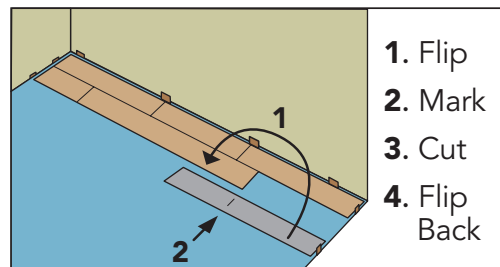

### STEP 11.

When you are unable to angle panels to install them (under door jams, toe kicks, radiators etc.), shave off the locking edge lip in the groove by using a wood chisel or plane. Apply a 1/8" bead of tongue and groove adhesive (PVA glue) along the modified groove as shown. Position the plank under the obstacle, then slide the plank gently into place, and tighten with the use of a pull bar and tap hammer.

Clean excess glue with a damp soft cloth and buff dry.

TIP: Use painter's tape across the joint to keep it tight until the glue sets.

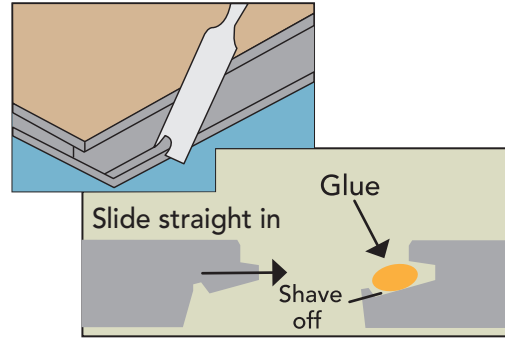

Power miter saw, table, circular and jig saws can be used to cut this flooring product.

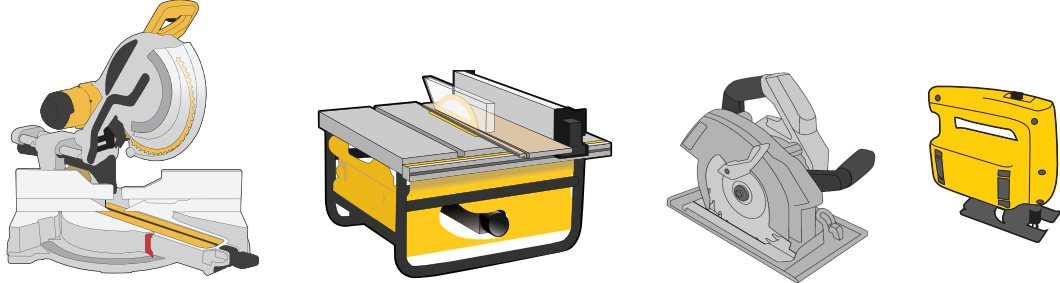

### FITTING AROUND IRREGULAR SHAPED OBJECTS:

Make a template to fit around pipes or irregular shaped objects. Place the pattern upon the plank and trace. Cut along the trace lines using a jig saw, and install plank.

Note: Be sure to leave the recommended expansion space around all fixed objects, cabinetry and metal door jams.

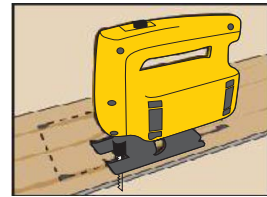

### PIPES:

When a pipe is passing through the floor make a hole on the plank 1" greater than the diameter of the pipe, cut the plank with a 45° angle towards the hole. The cut-off piece edges are glued in the position again. Do not glue to subfloor.



When there is single pipe on a wall, you can plan to have the end-joints meet at pipe, drill and install as shown.

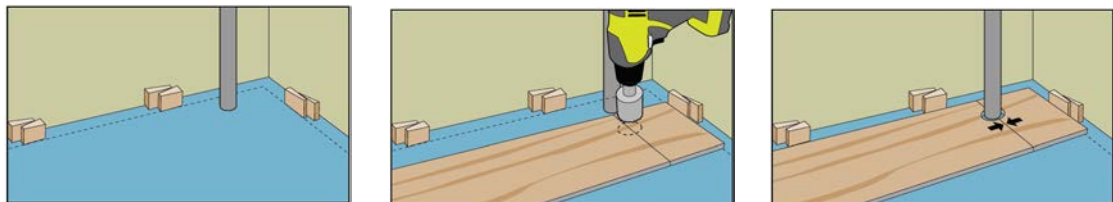

If there are multiple or larger pipes passing through the floor make hole(s) on the plank 1" greater than the diameter of the pipes, cut the plank with a 45° angle towards the hole. The cut-off piece edges are glued into position. Do not glue to subfloor.



### STEP 12.

The last row will need to be cut lengthwise to fit properly. Here's how to get it just right:

- A. Lay a plank of flooring right on top of the last full row in place.
- B. Then lay another plank of flooring on top of that plank, with the tongue side touching the wall.
- C. Use plank B as a straight-edge guide, and mark a line lengthwise on plank A.
- D. Cut plank A lengthwise along this line.
- E. Plank A can now be installed as the last row. We recommend you use edge glue for this last row.

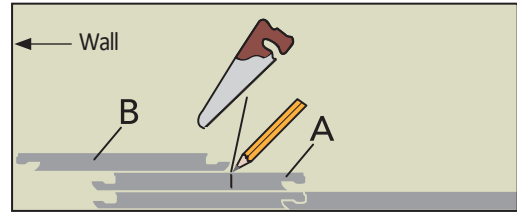

### STEP 13.

Remove all spacers

To ensure the floor is able to "float" freely, be sure to affix baseboards or moldings to the walls, not to the flooring

Also, never nail the first or last rows directly down to the subfloor! This option is not appropriate for floating floors.

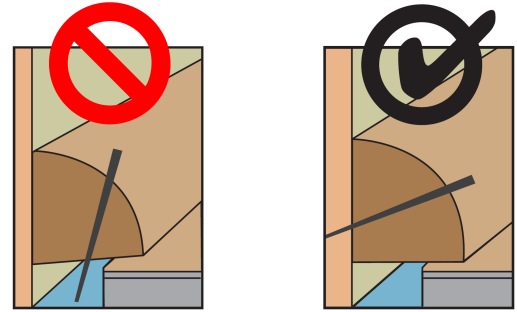

### STEP 14. TRANSITIONS

In areas where your new floor meets other types of flooring, such as carpet or tile, select an appropriate molding to get a professional looking and safe transition.

**U-Track** is attached to the substrate to secure the End Cap, T-Molding and Reducer transitions.

**End Cap** moldings transition from new floor to carpet, sliding doors, raised hearths, etc.

**Reducer** moldings transition from new floors to hard surfaces that are lower than the floor, such as vinyl or tile.

**Stair Nose** moldings are used when the new floor edge is at a step-down; Example: when the flooring meets at the top of a stairway "going down".

**T-Moldings** transition from new flooring to other hard surfaces of similar height, at doorways, and to "breakup" large expanses of connected flooring\*.

\*See "RUN WIDTH AND LENGTH" section above for details.

**3/4" Quarter Round** moldings are used to cover expansion spaces between the baseboards and the flooring.

#### REPAIRS:

Save extra planks from the initial order in the event that installed planks become damaged and repairs are needed. This will ensure lot number and shading compatibility.

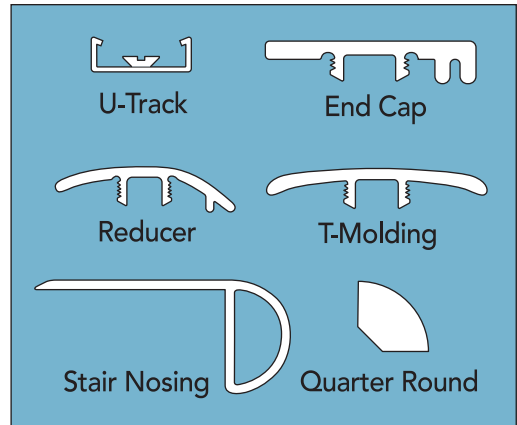

## HOME \* WARRANTY \* CARE

# CARE AND MAINTENANCE GUIDE

This Laminate Flooring is designed to bring beautiful wood and stone looks to your environment to fit your flooring needs and style, while also providing a solution with easy maintenance.

Created for residential applications, this flooring is extremely tough but still requires care and attention to keep it looking beautiful for years to come.

For day to day cleaning we recommend the floor to be swept and/or vacuumed. The vacuum head must be a felt brush type. Do not use vacuum with beater bars / very hard bristles. This will eliminate fine particles of dirt and grit that act like sandpaper which will scratch and / or dull the surface of your flooring.

Reduce the visibility of minor scratches using Bellawood Scratch Away.

Minimize abrasive material and dirt by placing mats on both sides of exterior doors and by using area rugs in high-traffic areas.

Use Bellawood Floor Cleaner to deep clean your whole floor and clean spots and soiled areas.

DO NOT use cleaning agents containing wax, oil or polish. Leftover residue will form a dull film.

DO NOT use steel wool or scouring pad, as they will scratch the floor.

Although the flooring planks are water resistant, you should promptly remove spills using a soft cloth reducing slip hazards.

**This flooring can be dented, gouged and scratched, this can be caused by but is not limited to: dropped objects, damaged shoe heels / soles, pet nails / claws, abrasive particles, etc.**

**The following steps will help reduce the risk of this kind of damage:**

- Floor protectors should always be installed to the bottom of furniture to prevent scratching and marking.
- Minimize abrasive material and dirt by placing mats on both sides of exterior doors and by using area rugs in high-traffic areas.
- We recommend the use of a hard surface (non-studded), non-rubber chair mat to protect your floor from office chairs with casters.
- Light, rolling furniture should be outfitted with broad-surface, non-staining casters that have been engineered for hard surface floors (casters should be a minimum of 1" wide and at least 2" in diameter).
- Never slide or roll heavy furniture or appliances across the floor.
- If flooring will be exposed to rolling traffic or heavy, appliances protect the flooring with plywood or hard-board panels.
- Remove shoes that are damaged exposing sharp metal, have cleats etc. before walking on the floor.

**We love our pets but occasionally accidents happen.**

- Cleaning the affected area should begin immediately upon discovery:
- Use absorbent paper tissue to collect as much of the deposited material as possible and properly dispose of it. Remove any existing residue with a suitable disinfecting cleaner.
- Repeat until all residue is removed. Buff dry. Clean, using Bellawood Floor Cleaner.
- The more time that elapses before removal, the more difficult a stain will be to remove.
- Keep pets' nails trimmed.

We recommend the use of NON-RUBBER backed mats that are labeled "colorfast" by the manufacturer.

Non-staining, vinyl-backed mats or woven rugs should be used at all door entries from outside to avoid discoloration from asphalt driveways, catch dirt, grit, sand, and other debris to help sustain the flooring.



We also recommend using protective mats around sinks and tubs to catch excess water and debris.

[HOME \\* WARRANTY \\* INSTALLATION](#)

# WALL \*

[QUICK CLICK](#)  
Method Click Here

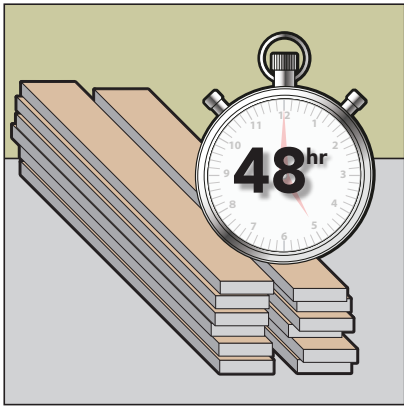
**Save time & avoid frustration! Please read these entire instructions before starting your installation, and A.I.M. for success!**

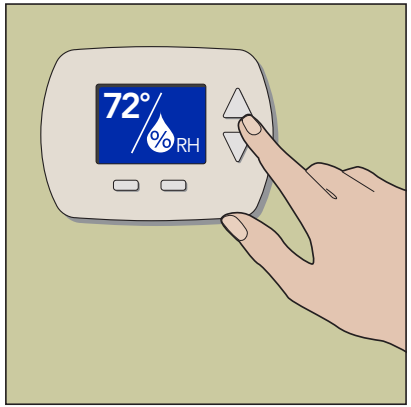
<p><b>AIM</b></p>	<p><b>AIM</b></p>	<p><b>AIM</b></p>
		
<p><b>Acclimate</b> Completely Acclimate your flooring to interior temperature for at least 48 hours. Temp. must be between 50°F – 85°F.</p>	<p><b>Install</b> Correctly Take time to review LL Flooring's installation guidelines to ensure that your installation goes well from beginning to end.</p>	<p><b>Maintain</b> Environment Interior temperature should be maintained between 50°F – 85°F and 40% – 75% Relative Humidity during the life of the floor.</p>



**Need Help?** To obtain installation assistance or product information concerning this flooring, contact the store of original purchase, or call the LL Flooring's customer care at 800-366-4204.



**WARNING! DO NOT SAND, DRY SWEEP, DRY SCRAPE, DRILL, SAW, BEADBLAST OR MECHANICALLY CHIP OR PULVERIZE EXISTING RESILIENT FLOORING, BACKING, LINING FELT, ASPHALTIC "CUTBACK" ADHESIVES OR OTHER ADHESIVES.**

These products may contain asbestos fibers and/or crystalline silica. Avoid creating dust. Inhalation of such dust is a cancer and respiratory tract hazard. Smoking by individuals exposed to asbestos fibers greatly increases the risk of serious bodily harm. Unless positively certain that the product to be removed is a non-asbestos containing material, you must presume it contains asbestos. Regulations may require that the material be tested to determine asbestos content. See current edition of the Resilient Floor Covering Institute (RFCI) publication, "Recommended Work Practices for Removal of Resilient Floor Coverings" for detailed information and instructions on removing all resilient covering structures. For current information, go to [www.rfci.com](http://www.rfci.com).



**LEAD WARNING:** Some paints and finishes in homes built before 1978 may contain lead. Exposure to excessive amounts of lead dust presents a health hazard. Prior to removing or sanding, comply with all applicable federal, state, and local laws, and reference the publication "Lead-Based Paint: Guidelines for Hazard Identification and Abatement in Public and Indian Housing" available from the United States Department of Housing and Urban Development regarding (1) appropriate methods for identifying lead-based paint and removing such paint; and (2) any licensing, certification, and training requirements for persons performing lead abatement work.



**MOLD AND MILDEW WARNING:** Prior to removing an existing resilient floor or when installing a new floor, if there are visible indications of mold or mildew or the presence of a strong musty odor in the installation area, the source of the problem should be identified and corrected before proceeding with the flooring work. Excessive moisture in the subfloor could promote mold, mildew, and other moisture related issues like the trapping of moisture emissions under the flooring, which may contribute to an unhealthy indoor environment. Mold has the potential to cause health problems and may produce allergens, irritants, and in some cases, potentially toxic substances. Before installing the new resilient flooring, ensure the underlayment and/or subfloor is allowed to thoroughly dry and that any residual effect of excessive moisture, mold, or structural damage has been corrected. Remediation measures may require structural repairs such as replacing the contaminated underlayment and/or subfloor, cleanup measures using appropriate protection and biocide, or hiring a professional mold and mildew remediation contractor. Consult EPA mold guidelines on EPA's website at <https://www.epa.gov/mold>



**WARNING:**

Drilling, sawing, sanding or machining wood products can expose you to wood dust, a substance known to the State of California to cause cancer. Avoid inhaling wood dust or use a dust mask or other safeguards for personal protection. For more information go to [www.P65Warnings.ca.gov/wood](http://www.P65Warnings.ca.gov/wood)

## This application only applies to product without an attached pad.

This document covers wall applications using laminate flooring without an attached pad only – do not install product with an attached pad.

Installation of your product should be in conformance with generally-accepted construction methods for interior wood-work per American National Standard ANSI/AWI 0620-2018 – *Finish Carpentry/Installation*.

This document covers wall applications using laminate flooring without an attached padding only. Installation of your product should be in conformance with generally-accepted construction methods for interior wood-work per American National Standard ANSI/AWI 0620-2018 – *Finish Carpentry/Installation*.

### RECOMMENDED USE:

- Residential interior use only.\* See the product's limited warranty for details.
- Install in good lighting.
- Do not install in exterior or wet areas. Do not install in boats, or other moving vehicles.
- Do not install directly to concrete or block walls.
- Walls need to be clean flat and dry.
- For safety and best performance: glue and nailing is required for all wall applications. These guidelines are for installation over conventional wood-framing with wall studs spaced no more than 24 inches on center.

### GRADE:

On, above and below grade.

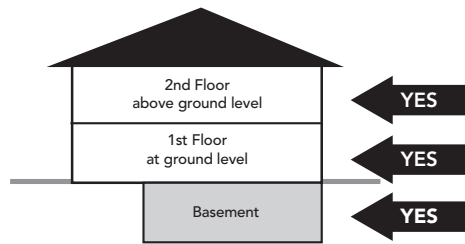

### JOBSITE CONDITIONS:

- The building should be enclosed with all doors and windows in place.
- Prior to delivery and install: All wet works (e.g. drywall taping, texture, painting, stucco etc.) should be complete and allowed to dry. The rooms should be at normal "lived-in" conditions with HVAC operational for at least one week prior to the installation when building is so equipped.
- When installing over basements and garages, ensure they are dry and well ventilated.
- Crawlspace must be dry with a minimum 18" from the bottom of the floor joist to the ground, Crawl space earth (or thin concrete slab) should be covered 100 percent by a vapor retarder of black polyethylene (minimum 6 mil) or any recommended puncture-resistant membrane, such as Class C, meeting ASTM D1745. Ventilation shall be per local building codes.
- All gutters should be in place and functioning properly. Yard grading should be sloped to run water away from the home foundation.
- The installer - not the manufacturer or retailer - is responsible for making sure that the site conditions are appropriate prior to installation of this floor.

### USER / OWNER / INSTALLER RESPONSIBILITIES:

- Install in good lighting.
- Product use constitutes acceptance. Visually inspect the product and determine acceptability before installation. Claims will not be accepted regarding visual defects after flooring has been installed. If any planks are unacceptable due to color, finish, milling or any other reason, it is your responsibility to determine to use them, hide them in areas like closets, trim off the imperfection, or not install them at all.
- A reasonable amount of installed flooring (up to 25% or 100 sq. ft. whichever is less) is enough to determine acceptance of quality.
- Retain a box label and keep on file with your receipt for future reference.
- These recommendations do not pertain to the suitability of products used as interior finishes on walls with regards to fire, flame spread, smoke, or any other related flammability characteristics. Care should be taken to ensure that any installation of products on walls meets all applicable federal, state/ provincial and local codes as well as other requirements.
- If quality issues are suspected stop the installation and call your local store or CUSTOMER CARE at 800-366-4204.

### HELPFUL TOOLS (as needed):

- Tape measure • Pencil • Chalk line • Stud finder • 6' level • Miter saw • Table saw • 60 tooth carbide tip saw blade • Drill + drill bits • 18 Gauge brad nailer • 1 1/2" - 1 3/4" Brad nails • Compressor with regulator • Hammer • Flat pry bar • Rubber mallet • Hygrometer (to monitor in-home humidity) • Species adjustable moisture meter (wood) • Caulk gun • Urethane construction adhesive • Step ladder • Screw drivers • Eye protection • Ear protection • Niosh dust mask • Gloves • Cloth rags • Color putty • Touch up markers • Speed square

### ACCLIMATION:

#### 48 hours

- Stack unopened boxes flat, and no more than eight cartons high in areas to receive new flooring. Do not remove plastic wrapping from the packaging until ready to install the floor.

**TEMPERATURE:**

For best product performance, ensure the temperature in the home is between 50° and 85F° before, during, and for the life of the flooring.

**RELATIVE HUMIDITY:**

For best product performance, maintain Relative Humidity (RH) at 30% or above to 70% or below with a maximum fluctuation of 30%, before, during and after the installation and for the life of the flooring. Ideal interior environmental conditions will vary from region to region and jobsite to jobsite, the relative humidity figures on your project maybe higher or lower. The key is to ensure that the change in relative humidity stays within a 30% range (e.g.30% to 60% or 35% to 65% etc...) and does not fluctuate beyond 30% for sustained periods, enough to affect the flooring. Home environments where the indoor Relative Humidity levels are below 30% or above 70% are not recommended.

**CUTTING ALLOWANCE:**

A 10' x 10' room has net 100 square feet will have flooring, but more product is required to allow for cutting which generates unusable pieces. Carefully measure the net square feet required, adding up multiple areas.

The table gives an approximate recommendation for cutting allowance: Quantities are always rounded up to the nearest box.

**Tip:** If more than half a box is not available for spares we recommend ordering an extra box.

**Please note:** Actual cutting waste may be lower or higher based on room layout. E.g. multiple rooms vs. one large area and "pattern" being installed.

Consider carefully before returning boxes. Keeping extra boxes is a great idea and inexpensive insurance against damage, if a repair is needed the product and batch will be the same, and you have options even if the product has been discontinued. Diagonal installations may require 5% extra material over and above the cutting and manufacturer tolerance allowance.

Net Area SqFt	Total with Cutting Allowance SqFt	% Applied
100	110	10
200	218	9
400	432	8
600	642	7
800	848	6
1000	1050	5
above 1000 SqFt add 5%		

**EXPANSION SPACE:**

1/2" is required top and bottom of the wall and both inside corners (sides).

**RUN WIDTH AND HEIGHT:**

Height - 10' maximum.

Width - No maximum when installed correctly

**CABINETS / FIXED FIXTURES:**

Flooring used as Wall Cladding is not a structural material. Do not fasten cabinets or fixtures to the flooring used as decorative wall covering.

**SURFACE PREPARATION:**

- All substrates must be structurally sound, dry, solid and stable.
- The substrate should be clean and free of dust, dirt, oil, grease, wax, soap, existing adhesives and adhesive residues, and any other substance that may prevent, reduce adhesion or affect product performance. Sponge wash with TSP (trisodium phosphate), to remove residues of greasy grime, mildew, chalked paint or anything that might affect the adhesive bond.
- Walls must be plumb and flat to 3/16" in 6' .
- All surfaces must be smooth and free of defects, voids, deviations, imperfections and irregularities. If the wall has a heavy drywall texture, it will need to be block sanded or skim coated and primed.
- Countersink any protruding screws. Use an appropriate patching compound to cover screw heads and correct any holes, bumps, cracks, depressions, etc.

Prime or paint as needed.

Do not install over substrates that have water damage, visible water stains or leaking windows. Remove protruding nails.

**Each project is unique and different. Installation advice or recommendations are given as a courtesy and not intended to take the place of an installer's visual inspection, expertise or informed judgment, the end user / contractor on-site is ultimately responsible for ensuring that selected products are appropriate for local conditions and / or their final use of the product.**



## GETTING STARTED:

### Step 1: Preparation

- Turn off power while working around wall outlets and light switches
- Remove existing wall base, trim, electrical cover plates, HVAC vent/return covers thermostats, etc., prior to installation.

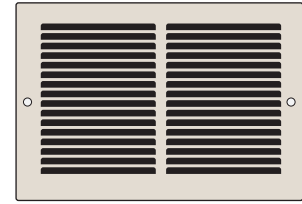
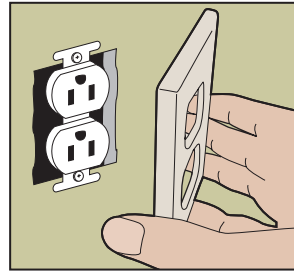
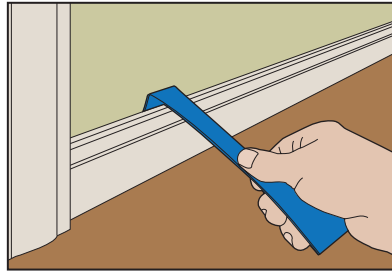

### Installation over drywall

- Use a 6' level or straight edge to insure the wall is flat in both directions.
- Walls need to be flat to within 3/16" in 6'.
- Correct any unevenness using a drywall joint compound.

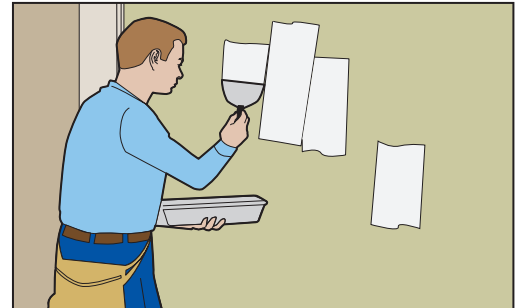
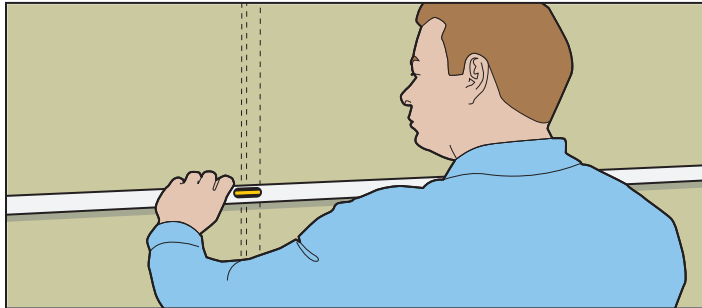

- Make repairs and remove any loose paint, wallpaper and all other contaminants that may affect adhesive bond (prime & paint repaired areas).

### Step 2: Identify and Mark Stud location

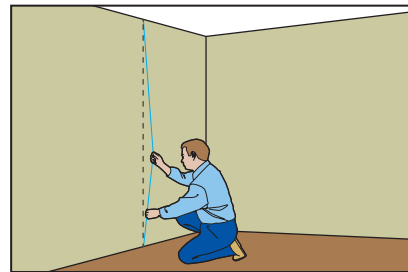
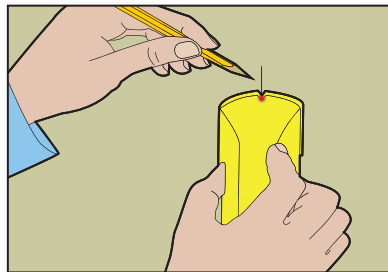

- Using a stud finder to identify studs, mark top and bottom of studs using a pencil.

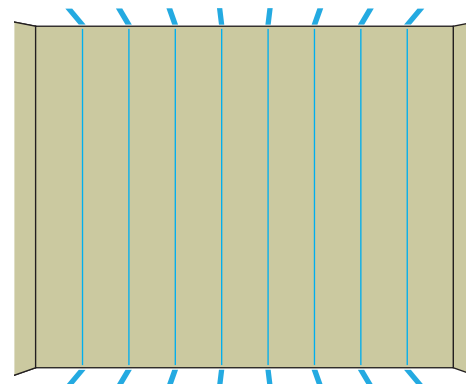
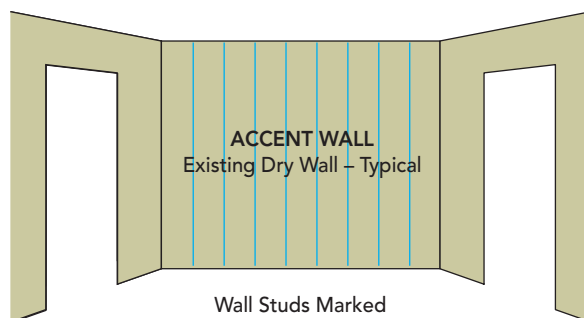

- Using a chalk line stretched between bottom and top mark, snap a line. Use painters tape at top & bottom of **each** stud on floor and ceiling to identify nailing points.

### Step 3: Establishing your starting line

Establish a working line on your feature wall by **measuring up** from the floor and at equal distances (approx. 12") from each corner of the wall. The distance from the floor to the line will be the width of the first row of planks used plus the minimum 1/2" expansion space.

- Mark these points on wall and snap a chalk line (as shown) parallel to the floor.
- Check that line is level in case of uneven floors.

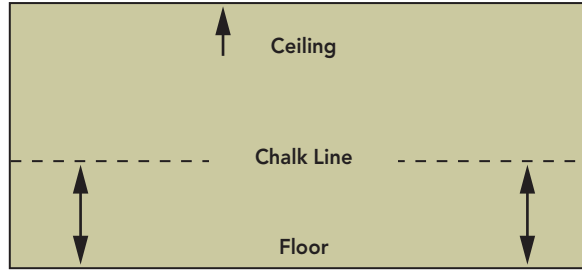

#### Preparation of planks for the starting row:

**Rack Out.** It is recommended that the planks are laid out on the floor prior to installing, this will give opportunity to remove unsatisfactory planks and ensure a pleasing layout prior to fixing in place.

**\*For ease of installation with Angle Tap applications; the tongue on the end of the plank must be removed.**

To avoid very narrow pieces at the ceiling; measure the distance between the floor and the ceiling, then divide this number by the width of the flooring planks. The fraction is the width of the last plank. Eg. for standard 8' wall:

$$\text{Floor} - \text{Ceiling} = 96" - 1" (1/2" \text{ expansion} \times 2) = 95"$$

$$\text{Width of Plank} = 4"$$

$$95 \div 4 = 23.75$$

Twenty full are required and last will be fraction x plank width

$$4" \times 0.75 = 3"$$

If width of last plank is less than 2.5", balance by cutting (Rip) bottom row of planks accordingly.

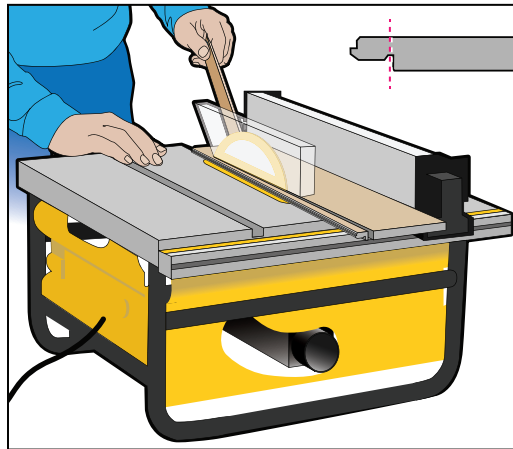
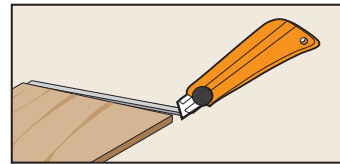

#### Board orientation

- Begin the first row with the groove facing up. **Install Right to Left.**

### Step 4. FIRST ROW:

**Glue and Fasten:** Use 1-1/4" – 1-3/4" 18 – 20 Gauge finish nails to secure to wall studs. Nails shall penetrate a minimum of 3/4 inch into studs spaced no more than 24 inches apart. Each plank in the first row shall be fastened with two nails into a stud and bottom plate (as shown below). Each plank shall be long enough to be attached to at least two studs.

- Use wedged spacers for a 1/2" minimum expansion gap between the subflooring and the first row. Place spacers adjacent to each plank joint.

**IMPORTANT:** adjust to keep line perfectly straight to your starting line!

Apply a 1/4" bead of Bostik Tread-Lock adhesive in a serpentine pattern on the back of each plank as installed.

- Place the plank on top of the spacers making sure top of plank is on the chalk line, leaving a minimum 1/2" expansion space at starting end wall.
- Be sure that there is an adequate transfer of adhesive transfer to the wall using a slight back and forth motion and firmly pressing the entire plank against the wall.



## Blind Nail and face nail this row as shown

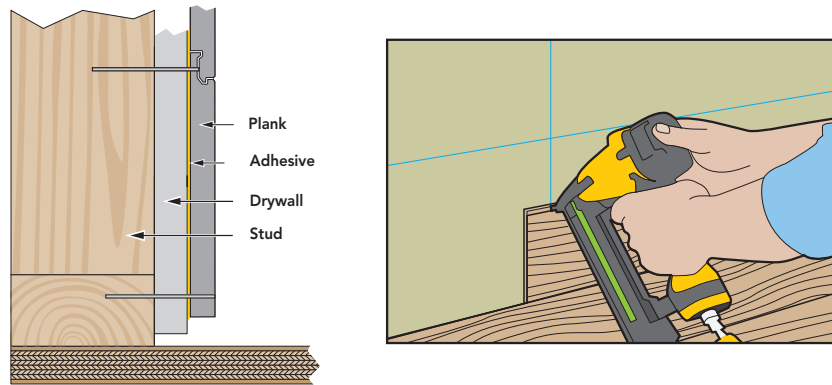

Use a level to double-check the levelness of the line between the two marks. Adjust line as needed with spacers. Secure this first row fully using adhesive and 2" finish nails or wood screws into pre-marked wall studs, placed approximately 2" above subfloor (these will be covered by your baseboard trim).

Using a finish nailer, nail at an angle into the groove of the plank to secure the plank to the wall studs. All nails should be counter-sunk so it does not interfere with the next plank. Continue with this method until you have completed the row.

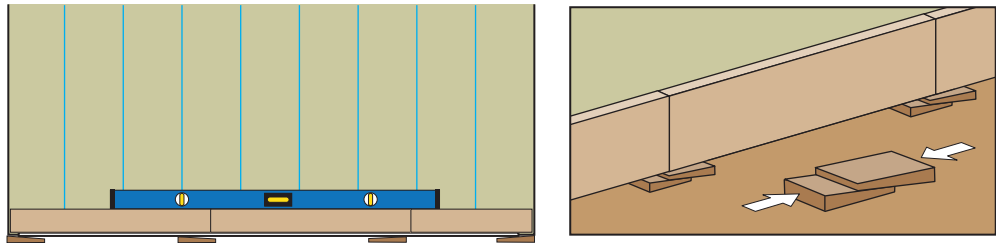

## CUTTING END-OF-ROW BOARDS:

The last board in each row must be cut to fit, while still maintaining a 1/2" expansion gap at the walls. Here's how:

1. Measure distance from last installed plank to end of wall.
2. Transfer this measurement (less 1/2") to plank you will cutting and mark it on the face.
3. Cut the plank at the mark.
4. Install as normal.

Using a finish nailer, nail at an angle into the groove of the plank to secure the plank to the wall studs. All nails should be counter-sunk so it does not interfere with the next plank. Continue with this method until you have completed the row.

## IMPORTANT:

When laying planks, stagger the end joints from row to row by at least 12" to ensure the structural integrity of your wall and a pleasing appearance. Pay close attention to avoid "stair step" or "H-patterns" appearing in the flooring.

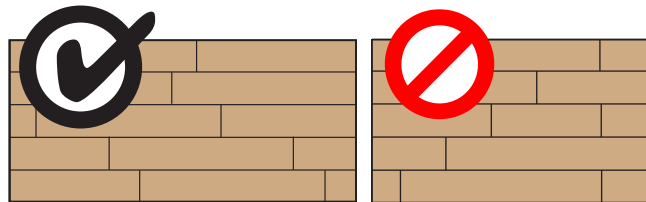

## Step 5: SECOND & CONSECUTIVE ROWS:

For best results, lay out planks on the floor to select placement of each plank. This will allow the proper mix of colors, patterns, etc... Continue using adhesive and blind nailing each plank as detailed in Step 4. Above.

- Working right to left, place the planks on top of previous row leaving a minimum 1/2" expansion space at starting and end walls. Using a finish nailer, nail at an angle into the groove of the plank to secure the plank to the wall studs. All nails should be counter-sunk so it does not interfere with the next plank. Continue with this method until you have installed the last full plank. **Fasteners should be long enough to penetrate a minimum of 3/4" into wall studs.**

Continue with this method until you have installed the last full row.

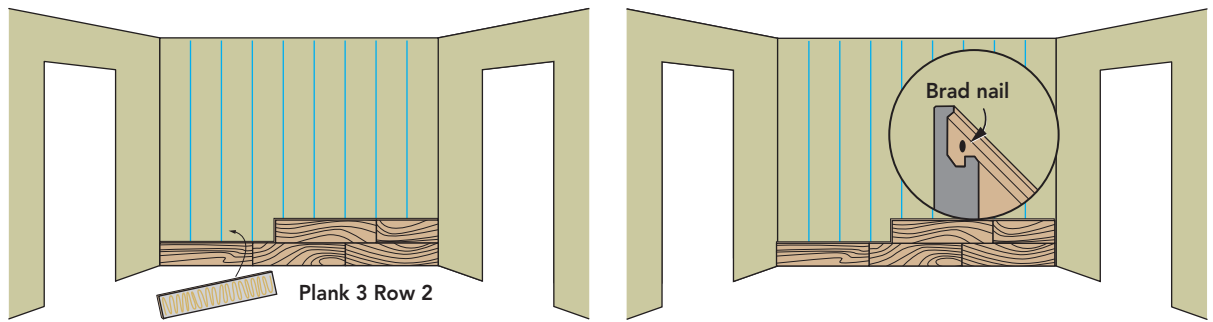

### CUTTING AROUND FIXTURES:

Measure and mark planks to fit around any existing outlets, switches, vents, etc.

#### Outlet "Box Extenders"

An electrical box extension shall be used as required by local building codes, to bring the switches and receptacles flush with the laminate.

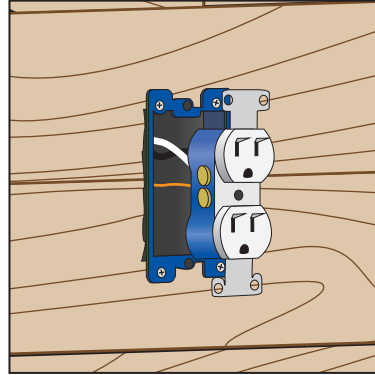

Do not cover receptacle retaining screw /surrounding fixture, to allow for bringing receptacle forward to accommodate for the thickness of new planks.

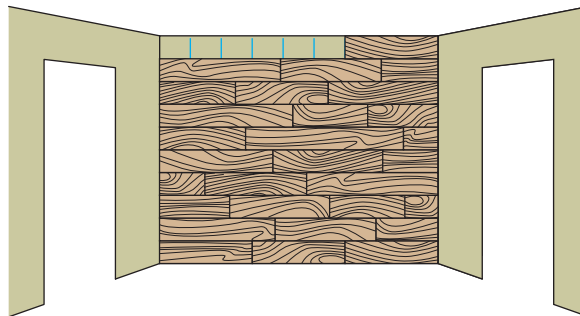

- The last row will need to be cut lengthwise (ripped down) to fit properly to the ceiling, leaving a minimum 1/2" for expansion.

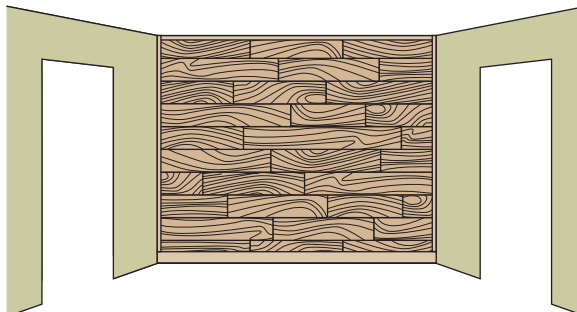

- Pre-drill and finish nail last row(s) as needed.

## Vertical Wainscot Style

Glue and Fasten: Nails shall penetrate a minimum of 3/4 inch into bottom plate and studs. Each plank shall be fastened with two nails into the bottom plate.

- Use wedged spacers for a 1/2" minimum expansion gap between the subflooring and the first row.

Place spacers adjacent to each plank joint.

**IMPORTANT:** adjust to keep line perfectly straight to your starting line!

Apply a 1/4" bead of Bostik Tread-Lock adhesive in a serpentine pattern on the back of each plank as installed.

- Place the first plank vertically on top of the spacers and check it is plumb using a level, leaving a minimum 1/2" expansion space at starting end wall.
- Be sure that there is an adequate transfer of adhesive transfer to the wall using a slight back and forth motion and firmly pressing the entire plank against the wall.

Continue with installation. When a stud is overlapped by a plank use 1-3/4" 18 Gauge finish nail to secure to wall stud. These nails should be positioned so the final trim piece covers them.

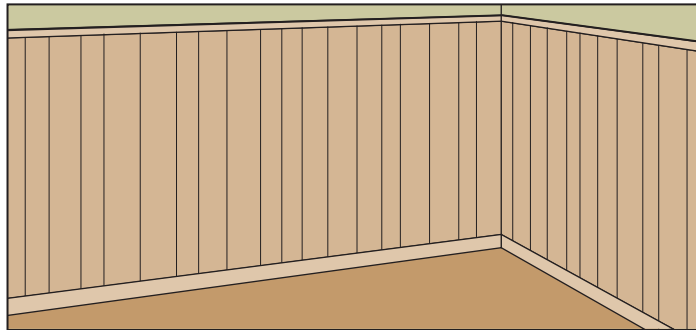

- Determine how many planks will be needed to fill the wall. For the best overall appearance, the first and last planks should be the same width.
- Measure to the appropriate height where you would like to stop the wainscot, plus 1/2" expansion space. Chalk a line between the two walls.

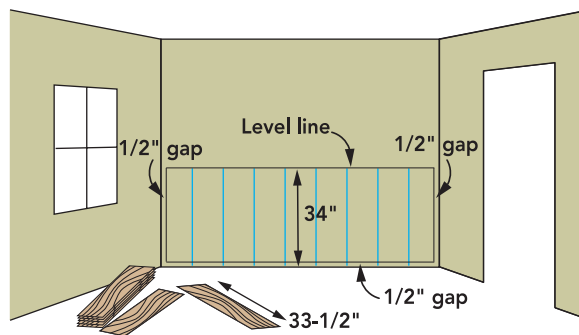

- Cut planks to fit to top chalk line.
- Apply a 1/4" bead of adhesive in a serpentine pattern on the back of the plank.

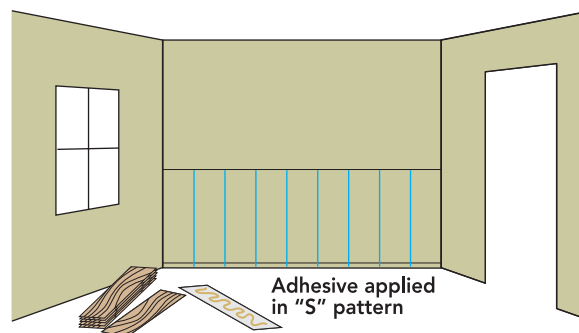

- Set plank in place with the top of the plank on the chalk line leaving a minimum 1/2" expansion space at bottom of wall.

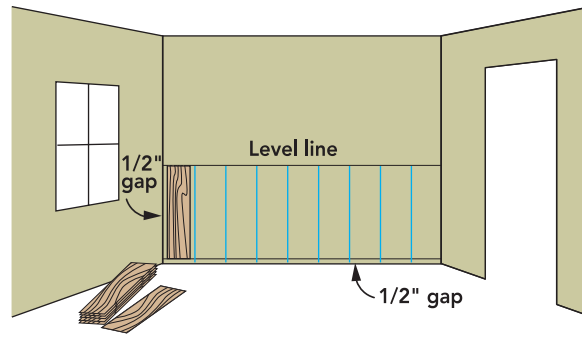

- Continue installation of the following rows using the same method as above.
- Fasten planks using adhesive and nail schedule described above.

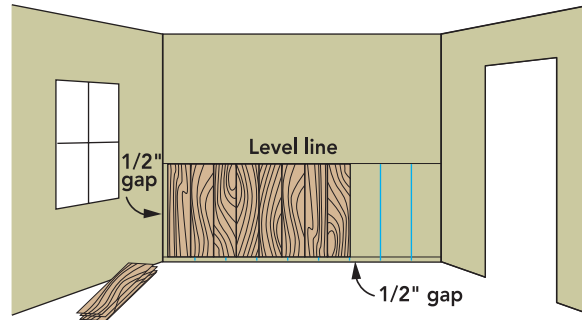

- The last row will need to be cut lengthwise to fit properly, leaving a 1/2" for expansion.

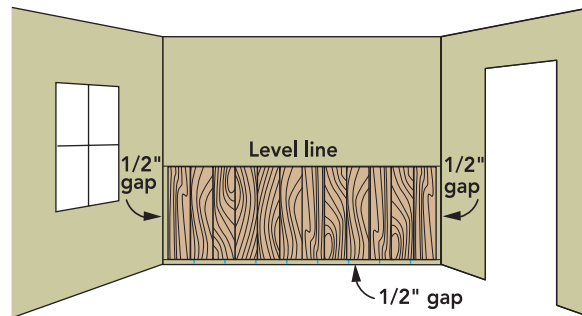

Trim out walls using 3/4" round (avoid nailing into planks).  
Install baseboard to cover gap along floor and Install threshold along top edge to finish wainscot wall.

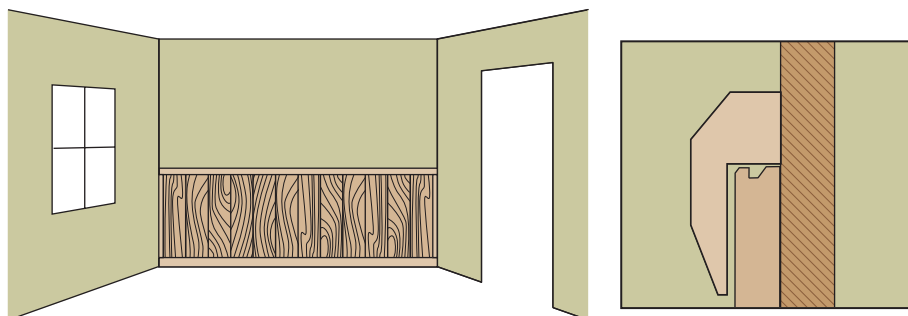

### **Finishing up — ALL METHODS:**

- Install the desired moldings to hide perimeter expansion gaps.
- Install electrical switch plates— see Cutting around Fixtures page 29.
- All electrical connections should be performed by a licensed electrician.

### **Applications**

**Base Board** – for hiding imperfections and adding a custom finish along any wall.

**Quarter-Round** - for covering the expansion left at walls and other fixed surfaces.

**Reducer Moldings** - used to transition to lower surface.

**End Cap** - for finishing the space at sliding glass doors, at bath tubs or transitioning to carpet.

### **CAUTIONS:**

#### **CABINETS AND FIXTURES:**

Flooring is not a structural material. Do not fasten cabinets or fixtures to the flooring used as a decorative wall covering.

Do not attach objects such as sconces, shelves or mount televisions directly to the wall or use nails in the wall for hanging objects. Instead, drill pilot holes and mount objects directly to wall studs with screws.

#### **Wall Sconces (lighting):**

Do not exceed the maximum recommended wattage of the light fixture.

[HOME \\* WARRANTY \\* CARE](#)