

HOME

# CORELUXE

*Premier - Signature - Essentials*

WARRANTY \* INSTALLATION \* CARE

EL 7'7" @ 7'7"



**WATERPROOF RIGID VINYL PLANK**

F U X J U b h < Y U h 5 d d f c j Y X

# LIMITED RESIDENTIAL CONSUMER WARRANTY

## *Coreluxe RVP Flooring Products*

*For Commercial Limited Warranty [click here](#)*

THIS LIMITED WARRANTY GIVES YOU SPECIFIC LEGAL RIGHTS, AND YOU MAY ALSO HAVE OTHER RIGHTS, WHICH VARY FROM STATE TO STATE.

THIS LIMITED WARRANTY CONTAINS ARBITRATION AND CLASS ACTION WAIVER PROVISIONS (SEE BELOW IN SECTION 9). THIS LIMITED WARRANTY ALSO CONTAINS LIMITATIONS OF LIABILITY (SEE BELOW IN SECTION 8).

WE LIMIT THE DURATION AND REMEDIES OF ALL EXPRESS OR IMPLIED WARRANTIES, INCLUDING WITHOUT LIMITATION THE WARRANTIES OF MERCHANTABILITY AND FITNESS FOR A PARTICULAR PURPOSE TO THE DURATION OF THIS EXPRESS LIMITED WARRANTY (SEE SECTION 2).

SOME STATES AND JURISDICTIONS DO NOT ALLOW LIMITATIONS ON HOW LONG AN IMPLIED WARRANTY LASTS, SO THE ABOVE LIMITATIONS MAY NOT APPLY TO YOU.

OUR RESPONSIBILITY FOR DEFECTIVE GOODS IS LIMITED TO THE STORE CREDIT AS DESCRIBED BELOW IN THIS LIMITED WARRANTY STATEMENT.

*[warranty information continues on following page]*

### **1. WHO MAY USE THIS LIMITED WARRANTY?**

LL Flooring, Inc. (“we,” “us,” and “our”) extends this limited warranty only to the consumer who originally purchased the product (“you” and “yours”) and only for residential use. It does not extend to any subsequent owner or other transferee of the product. **THIS LIMITED WARRANTY IS NOT TRANSFERABLE. THE LIMITED WARRANTY EXTENDS ONLY TO THE ORIGINAL END-CONSUMER.** For purposes of this limited warranty, a “residential use” is a product installation at a single-family home, apartment unit, townhouse, or other place where people live and, notwithstanding the forgoing list, excludes: (a) multi-family housing common areas; (b) any real estate property that is used for business or commercial activities; (c) any location used in whole or in part for business or commercial purposes; and (d) any location where foot traffic exceeds normal, residential foot traffic. We have the sole right to make the determination of whether an application is a residential use or another kind of use. For purposes of such determination, we may need to visit the location that relates to the warranty claim for inspection and use. This limited warranty does not apply any commercial / industrial use.

### **2. WHAT IS THE PERIOD OF COVERAGE?**

Subject to the requirements listed in Section 5 below, this limited warranty starts on the date of your purchase and lasts for the time period set forth in the chart below for your specific product (the “Limited Warranty Period”):

<b>DfcXi Wñ →XYbhjZVUhc b</b>	<b>@a jhX'F Yg]XYbh]U' K UffUblm</b>
<b>5''</b>	<b>@ZYha Y'K UffUblmi</b>

If, for any reason, we repair or replace the product, the Limited Warranty Period is not extended. We may change the availability and duration of this limited warranty at our discretion, but any changes will not be retroactive.

Where the Limited Warranty Period noted above provides for a “Lifetime” warranty, the duration of this limited warranty shall be the lifetime of the original purchaser so for as long as they own the flooring.

### **3. WHAT DOES THIS LIMITED WARRANTY COVER?**

During the Limited Warranty Period (defined above) and subject to the complete terms of this limited warranty, this limited warranty covers the following product aspects from defects in materials and workmanship of the purchased product (the “product”):

- *Limited Finish Wear Warranty.* Finish wear from normal residential use conditions resulting in the exposure of the decorative layer, subject to the exclusions provided in Section 4 below.

- *Product Structure.* The product will be free of manufactured defects in materials and workmanship.
- *Curling.* Vinyl peel and stick will be free from edge curling from normal residential use conditions.
- *Limited Waterproof Warranty.* The structural integrity of the product will not be significantly diminished by exposure to water during the Limited Warranty Period under normal residential use conditions. This limited warranty extends only to topical moisture and topical water exposure. Please note that this limited warranty relates only to the purchased product itself and does not warrant that your subfloor, residence, or any other items or properties will be safe from water damage because of the installation of this product.
- *Limited Pet Stain Warranty.* While the vomit, urine, and feces are still wet (and such wetness is not exceeding twenty-four hours), the product will resist staining and damage caused by the vomit, urine, and feces of domestic cats and dogs that occur during normal residential use, subject to timely attention under the Installation and Care Requirements (defined and discussed below). Please note that this limited warranty relates only to the purchased product itself and does not warrant that your subfloor, residence, or any other items or properties will be safe or resistant from these pet stains because of the installation of this product.
- *Delamination.* The product will not delaminate under normal residential use conditions.

#### **4. WHAT DOES THIS LIMITED WARRANTY NOT COVER?**

This limited warranty does not cover any defects or damages due to: (a) failure to strictly follow the Installation and Care Requirements (defined and discussed below) regardless of the installer; (b) transportation; (c) storage; (d) improper use; (e) modifications; (f) unauthorized repair; or (g) external causes such as accidents, abuse, or other actions or events beyond our reasonable control. In addition, this limited warranty does not cover any defects or damages due to the following:

- *Excessive Moisture.* Non-structural damages caused by moisture (such as mildew and mold) are excluded. In addition, moisture intrusions from concrete hydrostatic pressure, flooding, or plumbing leaks, along with high levels of alkalinity, can affect surrounding structure, walls, subfloor, fixtures, furniture, underlayment, moldings, trims, subfloor heating elements, or anything that is not the product. Damage from such conditions, including to the floor and subfloor, is not covered under this limited warranty.
- *Moisture Protection.* This flooring should not be used to seal an existing floor from moisture. This flooring cannot prevent problems associated with, or caused by flooding, excessive moisture, existing moisture, or alkalis in the subfloor or conditions arising from hydrostatic pressure. To be abundantly clear, this limited warranty does not cover damage to surrounding structure, walls, subfloor, fixtures, furniture, underlayment, moldings, trims, subfloor heating elements, or anything that is not the product itself. This limited warranty does not cover damage resulting from mold and/or mildew growth due to prolonged exposure to moisture, all casualty events involving water coming in contact with your floor and failures normally covered by insurance, including, but not limited to, damages caused by flooding or standing water from leaky pipes, faucets, or household appliances.

- *Site and Environmental Conditions.* Defects or damages resulting from: site conditions (such as extreme heat, radiant heat (for some products), or exposure to sand); indentations and scratches (caused by furniture, heavy rolling loads like un-modified wheels on caster chairs, castor chairs without protection mats, heavy electric wheel chairs, metal or thin wheels on appliances, tools, grit, heels, pets nails and claws, toys, etc.); improper maintenance and accidents; misuse and abuse. These items are not covered under this limited warranty
- *Heat Exposure.* This flooring is susceptible to changes in the conditions to which it is exposed including seasonal and environmental factors. Gapping or buckling due to expansion and contraction in extreme temperatures may occur.
- *Gloss Reduction.* Fading or loss of gloss (or glaze) is not finish wear and not a product defect covered under this limited warranty.
- *Other Finishes.* This limited warranty covers the factory-applied finish only. Applying another finish or sanding (such as in preparation for another finish) may damage the factory-applied finish and voids this limited warranty against finish wear.
- *Exterior/Outdoor Installations/Use.* This limited warranty does not cover exterior, outdoor, partial outdoor installations / use of the product.
- *Non-Flooring Installations.* Except where the product's Installation and Care Requirements designate the product as appropriate for wall installation, this limited warranty does not cover use of the products for installations on ceilings or other usages for purposes other than flooring (like furniture or countertops).
- *Visible Defects.* As discussed further below in Section 5.C., products installed with visible defects are not covered under this limited warranty. Accordingly, before installation, you and the installer should examine each product to ensure it is satisfactory.
- *Color and Shade Variations.* New or replacement flooring may not always match samples, printed color photography (including websites and catalogs), existing flooring or other products (such as cabinets, stair railings, trim and moldings). These variations should be expected. Inspect product before installation Claims for color and shade variation will not be accepted after the product is installed.
- *Discoloration/Fading from Mats.* This limited warranty does not cover discoloration due to use of rubber-backed mats or other incompatible mats.
- *Fading.* This limited warranty does not cover fading from exposure to sunlight
- *Odd Lots or As-Is.* An odd lot is flooring that is discounted and sold "As-Is" because it did not pass our rigorous inspection process. As such, odd lot product is not covered by this limited warranty.
- *Third-Party Purchases.* This limited warranty does not cover any purchases other than those made directly from LL Flooring in store, online, or by phone.

- *Radiant Heat.* Please consult the Installation and Care Requirements regarding whether your particular product may be installed over radiant heat. If your Installation and Care Requirements do not include materials regarding installation over radiant heat, your product is not appropriate for installation over radiant heat and not covered under this limited warranty for such installations. If your Installation and Care Requirements provide instructions for such installation, this limited warranty does not cover those products that are not installed according to the radiant heat manufacturer guidelines or not installed in compliance with the Installation and Care Requirements.
- *Removal and Replacement.* This limited warranty does not cover the cost of the removal or replacement of Countertops, cabinets, built-in appliances or other fixtures, installed on top of your floor.
- *Improper Installation and Maintenance.* This limited warranty does not cover any dissatisfaction or damage due to improper installation or maintenance. This includes any damages caused by any installation (regardless of the source of the installation advice) that conflicts with the applicable industry installation standards and product installation instructions—for example, damage caused by sub-surface, sub-flooring and jobsite environmental deficiencies, improper transportation, acclimation and storage.

## **5. HOW DO I MAINTAIN THIS LIMITED WARRANTY DURING THE LIMITED WARRANTY PERIOD?**

To maintain this limited warranty during the Limited Warranty Period, you are obligated to meet all of the following requirements for your use, installation, and maintenance of the product (the “Installation and Care Requirements”). The Installation and Care Requirements must be strictly followed for the limited warranty to remain valid and not be void.

- A. *Follow the Pre-Installation Requirements.* Prior to installing a single board, tile, or product, you or the installer must determine that the job-site environment and the sub-surfaces (including subfloor substrate) meet or exceed applicable industry and product standards, including, without limitation, moisture testing and controls. The product installation instructions discuss these standards and are provided in full below. These requirements must be strictly followed.
- B. *Comply with All Laws.* In your installation, maintenance, and use of the product you must comply with all laws and regulations, including, without limitation, all applicable environmental and building codes, regulations and laws.
- C. *Inspect All Products for Visible Defects.* Products installed with visible defects are not covered under this limited warranty. Accordingly, before installation, you and the installer should examine each product to ensure it is satisfactory. If any products are unacceptable for any reason, it is up to you to determine to use them, trim off the imperfection, or not install them at all. You should plan on being present during your installation to ensure that all required procedures are completed and products with visible defects are not installed. It is important to inspect individual boards and tiles and to frequently step back to observe the “whole picture” before installation is completed. *If quality issues are suspected before or during installation immediately contact the store where your floor was purchased or call us at 1-800-366-4204.*

- B. *Follow the Installation and Care Instructions.* It is your duty to make sure the installation requirements are strictly followed, including, without limitation, as they relate to the use of moisture barriers, installation tools, and the evaluation of job site conditions and moisture testing. The product's installation and care manual(s) are provided in this document below, and those terms and provisions are part of this limited warranty.

## **6. WHAT ARE YOUR REMEDIES UNDER THIS LIMITED WARRANTY?**

With respect to any defective product during the Limited Warranty Period, we will provide a LL Flooring store credit in the amount of the purchase price paid for the defective portion of the flooring (excluding any installation costs and labor). A store credit is the sole remedy under this limited warranty and can be used for store product purchases only. Provided, however, we reserve the right, in our sole discretion, to repair or replace such product (or the defective part) free of charge in lieu of a store credit. We will also pay for shipping and handling fees to return the repaired or replacement product to you if we elect to repair or replace the defective product.

This limited warranty applies to the colors, designs, and products available at the time of repair or replacement. If the original flooring is not available, LL Flooring will work with you to substitute a product of similar value. LL Flooring will always try to consider your needs.

We reserve the right to investigate, assess, and validate reported claims by, among other things, requesting samples from you for technical analysis and performing an inspection of the flooring and installation location.

## **7. HOW DO YOU OBTAIN WARRANTY SERVICE?**

To file a warranty claim during the Limited Warranty Period, you may:

- A. Visit the store where you purchased your floor;
- B. Call us at 1-800-366-4204; or
- C. Email via the "contact us" link at [www.LLFlooring.com](http://www.LLFlooring.com).

Claims must be submitted within the Limited Warranty Period and within ninety (90) days of the date that the problem with the floor is first discovered. No warranty claim will be serviced without contacting us through one of the methods listed above and any such claim must include you providing, accurate and complete information in a timely manner.

## **8. WHAT ARE THE LIMITATIONS OF LIABILITY?**

**THE REMEDIES DESCRIBED ABOVE IN SECTION 6 ARE YOUR SOLE AND EXCLUSIVE REMEDIES AND OUR ENTIRE LIABILITY FOR ANY BREACH OF THIS LIMITED WARRANTY. NOTWITHSTANDING ANY OTHER PROVISION OR TERM, OUR LIABILITY SHALL UNDER NO CIRCUMSTANCES EXCEED THE ACTUAL AMOUNT PAID BY YOU FOR THE DEFECTIVE PRODUCT OR DEFECTIVE PORTION THEREOF.**

**UNDER NO CIRCUMSTANCES SHALL WE BE LIABLE FOR ANY CONSEQUENTIAL, INCIDENTAL, SPECIAL OR PUNITIVE DAMAGES OR LOSSES, WHETHER DIRECT OR INDIRECT. WITHOUT LIMITING THE FORGOING SENTENCE, LOSSES, DAMAGES OR EXPENSES RELATING TO ANYTHING OTHER THAN THE FLOOR ITSELF ARE NOT COVERED, INCLUDING, WITHOUT LIMITATION, MISSED TIME FROM WORK, HOTEL STAYS, STORAGE FEES, KENNEL COSTS FOR PETS, REMOVAL OF DEFECTIVE FLOORING, INSTALLATION OF REPLACEMENT FLOORING, OR REMOVAL OR REPLACEMENT OF ITEMS BUILT ON TOP OF ANY FLOORING (FOR EXAMPLE, COUNTERTOPS, CABINETS, BUILT-IN APPLIANCES).**

**SOME STATES AND JURISDICTIONS DO NOT ALLOW THE EXCLUSION OR LIMITATION OF INCIDENTAL OR CONSEQUENTIAL DAMAGES, SO THE ABOVE LIMITATION OR EXCLUSION MAY NOT APPLY TO YOU.**

## **9. TERMS OF DISPUTE RESOLUTION**

**NO JOINT OR CLASS ACTIONS:** Neither you nor LL Flooring shall be entitled to join or consolidate claims in arbitration by or against other customers of LL Flooring with respect to other accounts, bring mass, class action, or consolidated claims in arbitration or a court of competent jurisdiction, or arbitrate or litigate any claim as a representative or individual of a class or in a private attorney general capacity. The arbitrator may not consolidate more than one person's claims and may not otherwise preside over any form of a representative or class proceeding.

**ARBITRATION:** The following informal dispute resolution procedure is available to you if you believe that we have not performed our obligations under this limited warranty. You must use this informal procedure before pursuing any legal remedy in the courts.

LL Flooring and you agree to attempt to resolve any disputes amicably. If, after thirty (30) days we are unable to do so, then you and LL Flooring each agree that any claim or controversy of any sort relating to our agreement, the Products or these limited warranty terms shall be determined by arbitration in the nearest U.S. city to the LL Flooring store where you purchased the products, before one arbitrator. At the option of the first to commence an arbitration, the arbitration shall be administered either by JAMS pursuant to its Streamlined Arbitration Rules and Procedures, or by the American Arbitration Association pursuant to its Commercial Arbitration Rules. The arbitrator shall have no power to add to, delete from or modify these limited warranty terms. Each of us shall have the right to conduct discovery to which we would be entitled had the dispute been resolved in a state court of general jurisdiction in the state of the LL Flooring store where you purchased the products. Judgment on the arbitrator's award may be entered in any court having jurisdiction. This clause shall not preclude either party from seeking provisional remedies in aid of arbitration from a court of appropriate jurisdiction. The arbitrator may, as part of the award, allocate all or part of the costs of the arbitration, including the fees of the arbitrator and the reasonable attorneys' fees of the prevailing party. The arbitrator shall only have the authority to resolve individual disputes between you and LL Flooring. Notwithstanding the foregoing, in addition to our rights set forth above, we may initiate proceedings directly in the appropriate court located in the U.S. city nearest the LL Flooring store where you purchased the products in connection with any claim to collect amounts due and owing by you.



## **10. NO OTHER TERMS**

**SAMPLES, DESCRIPTIONS, AND OTHER INFORMATION CONCERNING THE PRODUCT CONTAINED IN CATALOGS, ADVERTISEMENTS, OR OTHER PROMOTIONAL MATERIAL OR STATEMENTS MADE BY SALES REPRESENTATIVES OR DISTRIBUTORS ARE FOR GENERAL INFORMATIONAL PURPOSES ONLY AND ARE NOT BINDING UPON LL FLOORING. NO SALES REPRESENTATIVES, STORE MANAGERS, ACCOUNT REPRESENTATIVES, OR DISTRIBUTORS SHALL HAVE ANY AUTHORITY WHATSOEVER TO ESTABLISH, EXPAND OR OTHERWISE MODIFY LL FLOORING WARRANTIES. THE TERMS OF THIS LIMITED WARRANTY DOCUMENT MAY NOT BE AMENDED EXCEPT THROUGH A WRITTEN AGREEMENT TITLED “AMENDMENT TO LIMITED WARRANTY” AND SIGNED BY AN AUTHORIZED OFFICER OF LL FLOORING, PROVIDED, HOWEVER, THAT LL FLOORING MAY GENERALLY MODIFY, CANCEL, UPDATE, OR OTHERWISE CHANGE ITS PROSPECTIVE WARRANTIES FOR FUTURE SALES AT ANY TIME AND FOR ANY REASON.**

## **11. OTHER PROVISIONS**

The section headings provided in this limited warranty are for convenience and informational reference only and shall not affect the interpretation or construction of this limited warranty.

THE PROVISIONS OF THIS LIMITED WARRANTY ARE DEEMED TO BE SEVERABLE AND THE INVALIDITY OR UNENFORCEABILITY OF ONE PROVISION SHALL NOT AFFECT THE VALIDITY OR ENFORCEABILITY OF ANY OTHER PROVISION.



## **12. ADDRESS FOR LL FLOORING**

LL Flooring, Inc. is located at 4901 Bakers Mill Lane, Richmond, VA 23230.

[HOME \\* INSTALLATION \\* CARE](#)

# QUICK CLICK \* [GLUE DOWN Method Click Here](#)

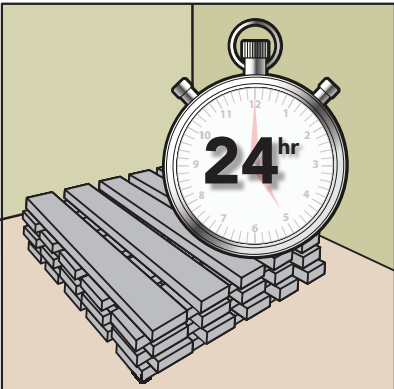
**Save time & avoid frustration! Please read these entire instructions before starting your installation, and A.I.M. for success!**

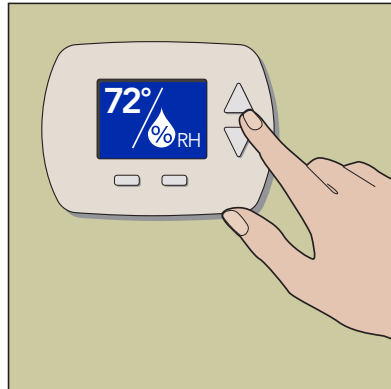
<p><b>AIM</b></p>	<p><b>AIM</b></p>	<p><b>AIM</b></p>
		
<p><b>5 WJJa UH' Completely</b>  <b>ACCLIMATION:</b> Not required if flooring and the jobsite are between 60°F – 80°F, otherwise acclimate for 24 hours between 60°F – 80°F.</p>	<p><b>Install Correctly</b>                  Take time to review LL Flooring's installation guidelines to ensure that your installation goes well from beginning to end.</p>	<p><b>A UjbHJb' Environment</b>                  After installation, maintain your flooring between the temperature ranges for your room size / expansion gap and contraction overlay (see Expansion and Contraction / Run Width and Length below).</p>

 **BYXX< Yd3** To obtain installation assistance or product information concerning this flooring, contact the store of original purchase, or call the LL Flooring's customer care at 800-366-4204.

 **WARNING! DO NOT SAND, DRY SWEEP, DRY SCRAPE, DRILL, SAW, BEADBLAST OR MECHANICALLY CHIP OR PULVERIZE EXISTING RESILIENT FLOORING, BACKING, LINING FELT, ASPHALTIC "CUTBACK" ADHESIVES OR OTHER ADHESIVES.** These products may contain asbestos fibers and/or crystalline silica. Avoid creating dust. Inhalation of such dust is a cancer and respiratory tract hazard. Smoking by individuals exposed to asbestos fibers greatly increases the risk of serious bodily harm. Unless positively certain that the product to be removed is a non-asbestos containing material, you must presume it contains asbestos. Regulations may require that the material be tested to determine asbestos content. See current edition of the Resilient Floor Covering Institute (RFCI) publication, "Recommended Work Practices for Removal of Resilient Floor Coverings" for detailed information and instructions on removing all resilient covering structures. For current information, go to [www.rfci.com](http://www.rfci.com).

 **LEAD WARNING:** Some paints and finishes in homes built before 1978 may contain lead. Exposure to excessive amounts of lead dust presents a health hazard. Prior to removing or sanding, comply with all applicable federal, state, and local laws, and reference the publication "Lead-Based Paint: Guidelines for Hazard Identification and Abatement in Public and Indian Housing" available from the United States Department of Housing and Urban Development regarding (1) appropriate methods for identifying lead-based paint and removing such paint; and (2) any licensing, certification, and training requirements for persons performing lead abatement work.

 **MOLD AND MILDEW WARNING:** Prior to removing an existing resilient floor or when installing a new floor, if there are visible indications of mold or mildew or the presence of a strong musty odor in the installation area, the source of the problem should be identified and corrected before proceeding with the flooring work. Excessive moisture in the subfloor could promote mold, mildew, and other moisture related issues like the trapping of moisture emissions under the flooring, which may contribute to an unhealthy indoor environment. Mold has the potential to cause health problems and may produce allergens, irritants, and in some cases, potentially toxic substances. Before installing the new resilient flooring, ensure the underlayment and/or subfloor is allowed to thoroughly dry and that any residual effect of excessive moisture, mold, or structural damage has been corrected. Remediation measures may require structural repairs such as replacing the contaminated underlayment and/or subfloor, cleanup measures using appropriate protection and biocide, or hiring a professional mold and mildew remediation contractor. Consult EPA mold guidelines on EPA's website at <https://www.epa.gov/mold>

 **WARNING:** Drilling, sawing, sanding or machining wood products can expose you to wood dust, a substance known to the State of California to cause cancer. Avoid inhaling wood dust or use a dust mask or other safeguards for personal protection. For more information go to [www.P65Warnings.ca.gov/wood](http://www.P65Warnings.ca.gov/wood)



## RECOMMENDED USE:

- For residential and commercial interior applications. See the manufacturer's website for details.
- Do not install in wet areas like patios and showers, or exterior areas. Do not install in boats or other moving vehicles.

## GRADE:

On, above and below Grade.

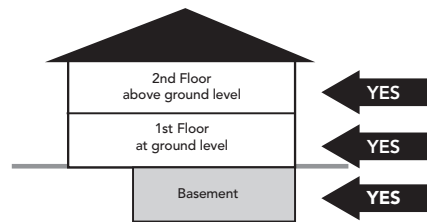

## JOBSITE CONDITIONS:

- The building should be enclosed with all doors and windows in place.
- Prior to delivery and install: All wet works (e.g. drywall taping, texture, painting, stucco etc.) should be complete and allowed to dry. The rooms should be at normal "lived-in" conditions with HVAC operational for at least one week prior to the installation when building is so equipped.
- When installing over basements and garages, ensure they are dry and well ventilated.
- Crawlspace must be dry with a minimum 18" from the bottom of the floor joist to the ground, Crawl space earth (or thin concrete slab) should be covered 100 percent by a vapor retarder of black polyethylene (minimum 6 mil) or any recommended puncture-resistant membrane, such as Class C, meeting ASTM D1745. Ventilation shall be per local building codes.
- To avoid damages to the floor's finish, all construction activity should be completed before installing this floor.
- All gutters should be in place and functioning properly. Yard grading should be sloped to run water away from the home foundation.
- Ensure that exterior doors and appliances have sufficient clearance to accommodate the new flooring. Do not undercut metal door jambs before first confirming it doesn't violate local building and fire codes.
- The installer - not the manufacturer or retailer - is responsible for making sure that the site conditions are appropriate prior to installation of this floor.

## USER / OWNER / INSTALLER RESPONSIBILITIES:

- Install in good lighting.
- Product installation constitutes acceptance. Visually inspect the product and determine acceptability before installation. Claims will not be accepted regarding visual defects after flooring has been installed. If any planks are unacceptable due to color, finish, milling or any other reason, it is your responsibility to determine to use them, hide them in areas like closets, trim off the imperfection, or not install them at all.
- A reasonable amount of installed flooring (up to 25% or 100 sq. ft. whichever is less) is enough to determine acceptance of quality.
- Retain a box label and keep on file with your receipt for future reference.
- If quality issues are suspected stop the installation and call your local store or CUSTOMER CARE at 1-800-366-4204.

## TOOLS AND MATERIALS:

- Tape Measure • Pencil • Chalk line • 6' level • Framing square/Metal straight edge • Screed • Utility knife (blades)
- Miter saw • Table saw • 60 tooth carbide tip saw blades • Jamb saw • Drill • Drill bit set • Hammer • Flat pry bar • Broom
- Eye protection • Ear protection • Knee pads • Niosh dust mask • Gloves • Hygrometer (to measure /monitor in-home humidity) • Moisture meter • Color putty • Touch up markers • Speed square

## ACCLIMATION: 24 hours

This product requires no acclimation if its temperature and the jobsite are between 60°F and 80°F.

If a method is not available for testing temperature of the flooring (e.g. an infrared Thermometer Temperature gun), or flooring is outside of this range, allow the flooring to acclimate for 24 hours at the approved temperature.

- Stack boxes flat, and no more than eight cartons high in areas to receive new flooring.

## TEMPERATURE:

After installation maintain your flooring between the temperature ranges for your room size / expansion gap and contraction overlay (see Expansion and Contraction / Run Width and Length below).

## RELATIVE HUMIDITY:

No limits.

## CUTTING ALLOWANCE:

A 10' x 10' room has net 100 square feet (Sq. Ft.) – the actual area that will have flooring – but more product is required to allow for cutting which generates unusable pieces.

Carefully measure the net square feet required, adding up multiple areas

**Quantity Determination:**

Quantities are always rounded up to the nearest box.

**Tip:** If more than half a box is not available for spares we recommend ordering an extra box.

**Please note:** Actual cutting waste may be lower or higher based on room layout. E.g. multiple rooms vs. one large area and "pattern" being installed. E.g. diagonal installations will require more cutting allowance.

Consider carefully before returning boxes.

Keeping extra boxes is a great idea and inexpensive insurance against damage, if a repair is needed the product and batch will be the same, and you have options even if the product has been discontinued.

Diagonal installations will generally require 5% more material over and above the cutting allowance given above.

Net Area SqFt	Total with Cutting Allowance SqFt	% Applied
100	110	10
200	218	9
400	432	8
600	642	7
800	848	6
1000	1050	5
above 1000 SqFt add 5%		

**EXPANSION AND CONTRACTION SPACE:**

**Floating:** Run lengths and Run widths greater than the maximum run allowed for the expansion gap and contraction overlay chosen will require transitions to "break up" larger installations. Typically, these are placed at doorways, adjoining rooms, archways, connections to hallways etc. Allow recommended expansion gap between the flooring and all vertical obstructions (walls, door jams, pipes, staircases, posts, fixtures, built-ins, etc.)

**Note:** For run lengths and widths please review table below. This grid gives recommended gap and overlay for various length and widths at various temperatures. e.g. if your run length is 60' and width is 60', and your temperature variation is 30°F – 110°F, then 1/2" gap and 1/2" overlay is required. Below are examples of 1/2" and 3/4" expansion gap and contraction overlay.

		TEMPERATURE RANGE °F			
		50 – 90	40 – 100	30 – 110	20 – 120
RUN LENGTH AND WIDTH IN LINEAL FEET	20	1/4" GAP AND OVERLAY			
	40	1/2" GAP AND OVERLAY			
	60	1/2" GAP AND OVERLAY			
	80	3/4" GAP AND OVERLAY			

The temperature range is the actual temperature of the flooring which is affected by the substrate, sunlight and ambient temperature.

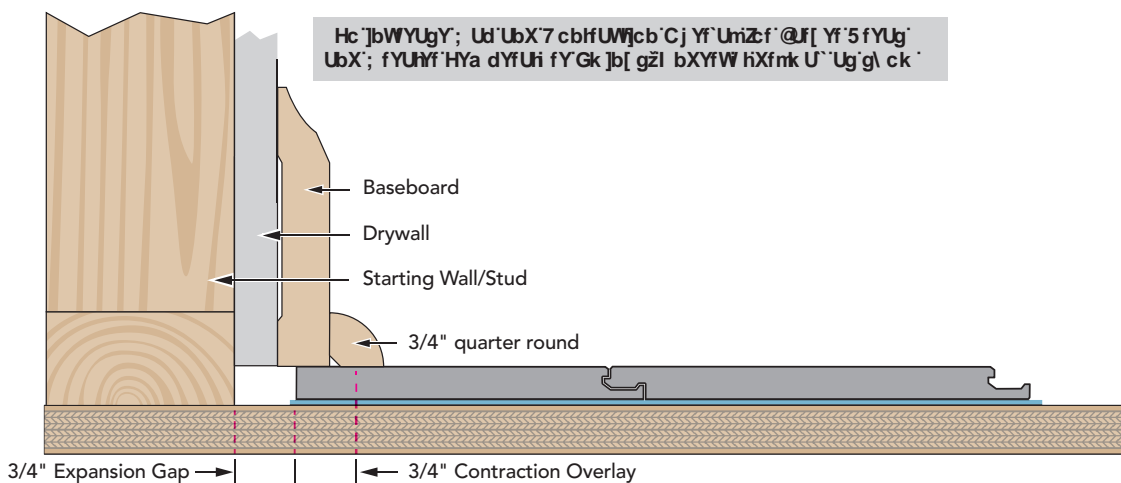
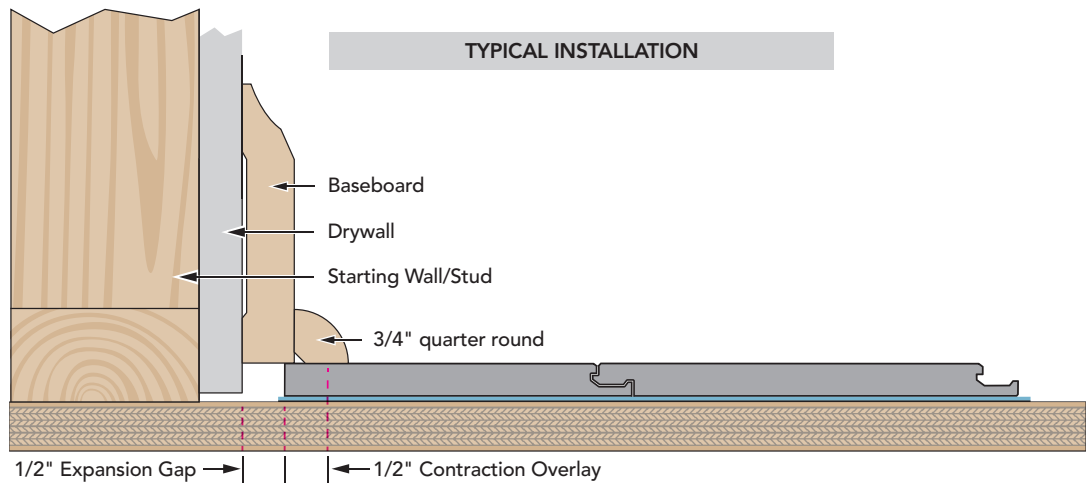

If the room has electric baseboard heaters, leave a minimum of 3/4" between the surface of the flooring and the bottom of the heaters, allowing heat to circulate properly.

**NOTE:** Gapping and buckling can develop if expansion space and contraction overlay requirements are not followed.

**8CCFK5MG#CD9B-B; G69HK99B'FCCAG.** When flooring lengths (long sides) run "parallel" within a doorway / opening between areas (joined continuously) it is recommended that a thin even bead of flexible (Gel Control) super glue or hot-melt glue (for plastics) is applied to the locking mechanism at the opening(s), to reduce the probability of gaps forming from movement of the flooring due to possible temperature differences from room to room.

**756-B9HG#: 198 : 1HI F9G.**

Do not install under fixed cabinets or islands of any type.

**GI B @; <H**

Mci f'Zccf]b[ 'a UmW Ub[ YW'cf'k ]h 'dfc'cb[ YX'Yl dcci fY'lc'gi b ][ \ H'l gY'cZk ]bXck 'W'j Yf]b[ gZg\ UXYgZcf 'h]b]b[ ' mci f k ]bXck gZ]g'fYW'a a YbYX'lc'g'ck 'h ]g'dfcWgg

**GI 6: @CCFG'B998 'HC'69.'7 @5B'E: @H'E8FM**

K ccX'gi VgfUHY'g'a i ghVY'gfli Wi fU'migci bX'UbX'ZY'Zca 'a cj Ya Yb]cf'XYZYW]cb

**7 @5B.**

Free from particles including but not limited to: dust, dirt, and grit.

**GI 6: @CCF'AI GH'69': @H'5B8 'GACCH<**

**: @H.'**

Subfloors must be flat within 1/8" over 6' and 3/16" over 10' and smooth, abrupt peaks and valleys must be avoided.

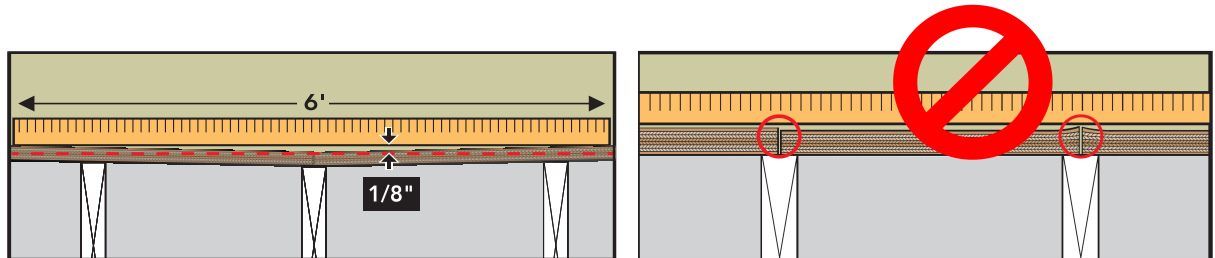

- a dfcdYf'gi VgfUHY'cf ZUbYgg'WUb'fYgi 'h]b[ UdgZgei YU\_gZdfYa Ui fY'k YUf'cb'gi fZJW'UbX'dccf'd'Ub\_'Z]h]b[ Xi f]b[ UggYa V'nl 7 cffYWiUbm]ggi Yg"

**8FM**

See Moisture Testing requirements below.

Do not install this flooring over plywood underlayment attached to concrete, unless it is known that an appropriate moisture barrier has been installed (all applications).

**KCC8 'GI 6: @CCF'PREPARATION:**

- Screw down loose or squeaky sections of plywood and replace areas that are damaged.
- To address flatness concerns sand or plane high spots and fill the low spots with a material approved for use under wood flooring.
- 15 - 30 lb. roofing felt, vinyl tile or similar can be used (in layers) to build up low areas on wood subfloors to a max. 3/16".
- Installers are responsible to use materials to ensure product performance.
- Substrates that are not level/flat due to structural deficiencies should be repaired by a licensed contractor.
- Never apply plastic sheet over wood subfloors.

**GHFI 7HI F5 @F9EI F9A9BHG.**

Note that joist spacing determines minimum subfloor thickness.

- Joist spacing 16" on center (OC) or less
  - Plywood: Minimum of (5/8", 19/32") Oriented Strand Board (OSB): minimum (3/4", 23/32") Advantech minimum (3/4", 23/32")
  - Joist spacing 16" up to 19.2" (OC)
    - Plywood: Minimum of (3/4", 23/32") Oriented Strand Board (OSB): minimum of (3/4", 23/32")
    - Joist spacing over 19.2" up to maximum 24" (OC)
      - Plywood: Minimum of (7/8") Oriented Strand Board (OSB): Minimum of (1") or two layers of subflooring or brace between truss/joists in accordance with local building codes.

## MOISTURE TESTING:

Use a meter that is species / material adjustable. E.g. Ligno-scanner SDM or mini-Ligno DX/C moisture meter.

- If using alternate meter check that meter can be used with the subfloor material in question.  
Test sub-floor in multiple locations, with an appropriate wood moisture meter, it's recommended to test 20 location per 1000 square feet and average the results. Moisture readings must not exceed 12%.
- Higher readings indicate a moisture concern that needs to be addressed before installation can begin.
- For future reference, documenting and saving the test results is recommended.

## SUBFLOORS NEED TO BE: CLEAN – FLAT – DRY:

Concrete substrates must be structurally sound and free from movement or deflection.

7 @ 5 B.

GI 6: @CF AI GH'69: @H'5 B8 'GACCH  
: @H'

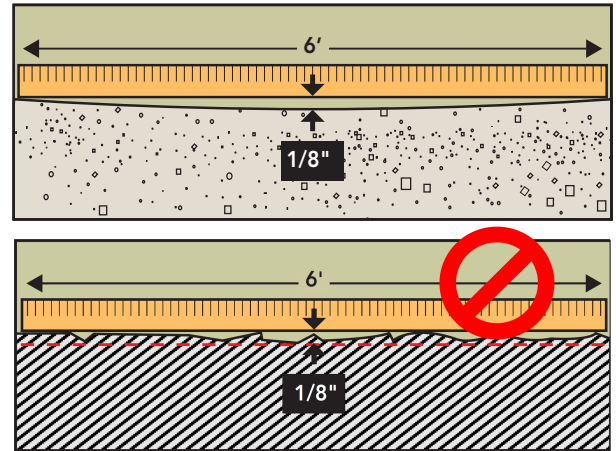

Correct any issues.

8 FM

## 7 CB7 F9H9 GI 6: @CF PREPARATION:

: @5HB; '5 DD@7 5HCBG.'

- 6 mil polyethylene moisture barrier- seams overlapped 4"- 6" and taped using a waterproof adhesive tape (e.g. duct tape) must be used or LL underlayment with a water vapor permeance of 0.1 perm or less when tested in accordance with the ASTM E96.
- **Roll-Cote by Bostik**, a new roller applied moisture barrier alternative to 6 mil poly. Two coats of Roll-Cote must be applied to perform as a Moisture-Vapor-Barrier. Follow manufacturer's TDS / installation guide. [Click here for complete details](#)
- Do not proceed with installation if concrete is wet or shows sign of dampness. Excessive moisture could lead to mold / mildew. (Underlayment's with a vapor retarder still require this moisture barrier).
- To address flatness concerns; Grind down\* high spots and fill in low spots with an appropriate Portland cement based patch or self-leveler (allow to cure fully) prior to installing floor. **\*CAUTION: Follow OSHA guidelines (29 CFR 1926.1153) regarding silica dust hazards.**
- 15 / 30 lb. roofing felt or vinyl tile can be used to build up (in layers) low areas on concrete subfloors.

@; <HK 9; <H'5 @9FB5HJ9 GI 6: @CFG.'

\*CAUTION: Follow OSHA guidelines (29 CFR 1926.1153) regarding silica dust hazards.

9L-GHB; ': @CFG.

- This flooring can be floated over existing clean, flat, dry, well bonded/secured tile, vinyl and wood flooring\*.
- \* **Do not install** over wood flooring installed over concrete unless it is known that an appropriate moisture barrier has been installed over the concrete.
- Do not install over cushioned vinyl flooring, or existing floating floor products.
- Do not install over carpet and padding.
- To prevent telegraphing a suitable embossing compound may be needed to conceal grout lines and heavily textured tiles. To prevent telegraphing a suitable embossing compound may be needed to conceal grout lines and heavily textured tiles

## RADIANT HEAT SYSTEMS:

This Coreluxe flooring product may be installed over approved QuietWarmth film systems.

QuietWarmth comes in several sizes to configure to your individual space whether Large or small!

Call 1-800-366-4204 or see you local store for complete details.

[Please review manufacturer's technical data sheet for more details.](#)



## RADIANT HEAT FILM FOR FLOATING FLOORS

- This flooring is suitable for installation over Hydronic Radiant heating systems provided that the heating element is not in direct contact with the product.
- New heating systems should be running two weeks before installation to remove residual moisture from the subfloor.
- Lower temperature of heating system to 60°F for one week prior to installation.
- Gradually increase temperature in increments of 10° per day to avoid “shock” to resilient flooring.
- Surface temperature should not exceed or sustain 85°F.
- Because of the wide array of systems on the market each with its own features and applications, it is recommended that the user consult with the heating provider for best practices and installation methods.
- It is the user’s responsibility to confirm the suitability of any selected or existing radiant-heating system that will be used in conjunction with this flooring.
- Rugs placed over radiant heated flooring can increase the surface temperature in that area by 3°- 5°F

## RECOMMENDED PATCHES / LEVELERS:

- Cement Patching- Bostik WebcreteR 95™
- Total Surface Self-Leveling- Bostik SL-175™ (plus Primer Pro)

Follow manufacturer’s TDS / installation guide.

## ADDITIONAL UNDERLAYMENT:

- Quality Underlayment is highly recommended. It can help smooth out minor subfloor imperfections, provide moisture protection over all subfloors and have added insulation and sound control properties.
- NOTE: Some acoustical “vapor retarder” underlayments have limits of moisture protection and are not a substitute for a 6 mil polyethylene moisture barrier. Underlayments that have a water vapor permeance of 0.1 perm rating or less when tested in accordance with ASTM E96 can be used in place of 6 mil poly sheeting.
- **We recommend the following underlayments to maintain your manufacturer’s warranty and provide moisture protection of 0.1 perm rating or less:** [QuietWalk Max](#) (10056877), [QuietWalk Versa](#) (10056873) [QuietBoard](#) (10056807) and [EcoSilencer Max](#) (10056803).
- Be sure to follow manufactures installation guidelines to include additional waterproof tape as required.
- **Important: Additional underlayment / padding is not recommended for thin (4mm and below) vinyl flooring products.**
- This flooring is waterproof, however, moisture intrusions from concrete via hydrostatic pressure, flooding, or plumbing leaks, along with high levels of alkalinity, can affect floor coverings over time.
- Moisture can also be trapped below the flooring and create mildew or mold
- LL offers a wide variety of underlayments, please call 1-800-366-4204 or see your local store for recommendations

## ADDITIONAL NOTES:

When moving furniture and heavy equipment, use luan board, plywood, or other similar covering to protect the floor.

**Each project is unique and different. Installation advice or recommendations are given as a courtesy and not intended to take the place of an installer's visual inspection, expertise or informed judgment, the end user / contractor on-site is ultimately responsible for ensuring that selected products are appropriate for local conditions and / or their final use of the product.**

# How to Assemble Quick Click Flooring

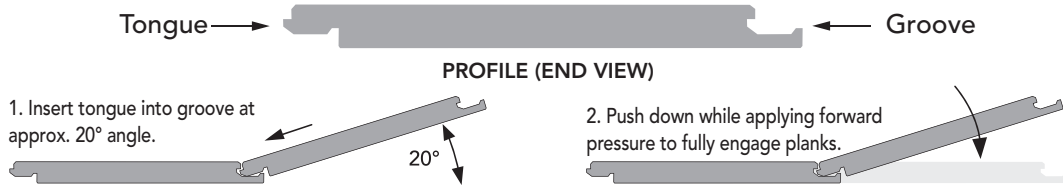

NOTE: Tongue image is for illustration only. The actual locking shape of your floor may differ.

Cut off the tongues on the first  
Be sure locking system is fully engaged!  
Planks must be flat in relation to each other (on  
all sides) without gaps before continuing install.



B9J9F'I G9'5'H5DD-B; ' 6 @C7?'CF'DI @@65F"  
H<9G9'K=@@85A5; 9'  
MCI F': @CCF'5B8''  
JC-8'H<9'K5FF5BHM

## GETTING STARTED:

Important: Do not cut metal door frames before first confirming it does not violate local building and fire codes. Any metal doors must be addressed by a specialist to adjust.

Check for alarm or other low voltage wiring before cutting.

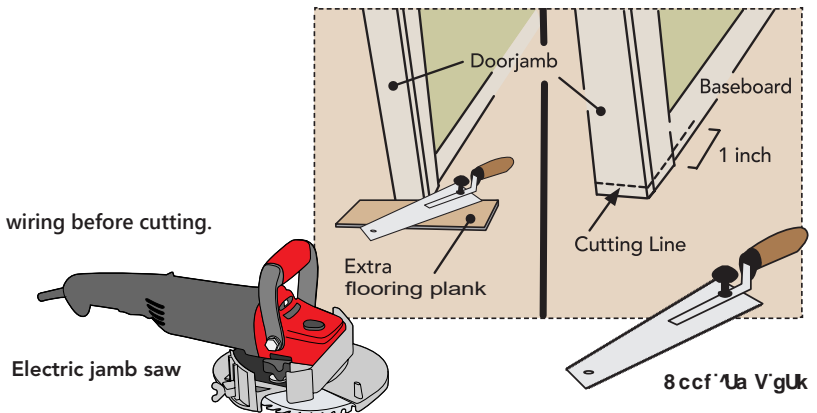

### A:

Check that subfloor is flat to within specifications per details found under "CLEAN-DRY-FLAT" in previous section. 7 cffYVWiUbnjggi Yg"

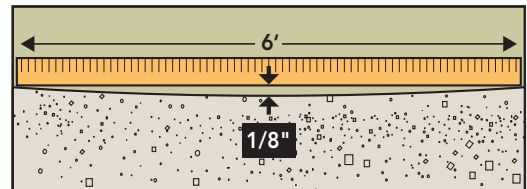

### 6.

Install 6 mil polyethylene film vapor barrier if subfloor is concrete.  
Never install 6 mil poly over wood substrates!NOTE: Cushioned "vapor retarder" underlayment are not a substitute for a 6 mil polyethylene moisture barrier.

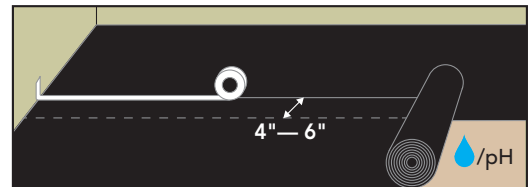

### 7 "

Note:  
If specified, install customer preferred cushion\*.  
\*See page 15 for approved underlayment.

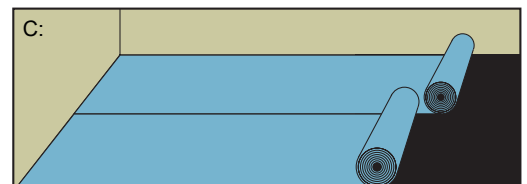



## STEP 1. LAYOUT:

**IMPORTANT:** Mix materials from several cartons to ensure best overall color/shade appearance of the installed floor.

Preparation of planks for the starting row when needed:

Eg. for a ' room:

**NOTE:** If a narrow strip is unavoidable for the last row, the final two rows can be glued together at the joint using a thin even bead of flexible (Gel Control) super glue or hot-melt glue (for plastics) at the long seams to avoid board separation.

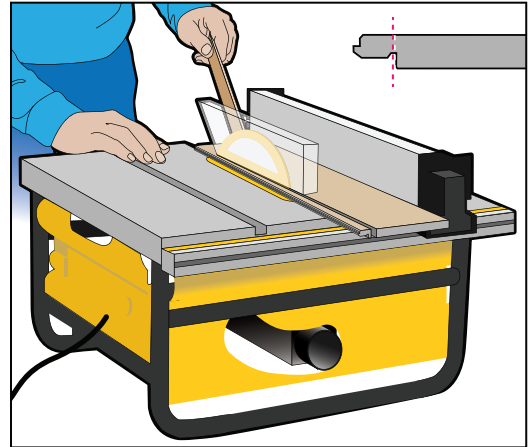

## STEP 2: ESTABLISH A WORKING LINE

In at least two places, measure out equal distance from your starting wall, 12"–18" from each corner.

The distance from the starter wall to the line will be the width of the plank used on first row, the expansion space. Mark these points and snap a chalk line (as shown) parallel to your starting wall. Be sure to maintain proper gap around all vertical obstructions, e.g. newel posts, raised hearths, upright pipes, etc.

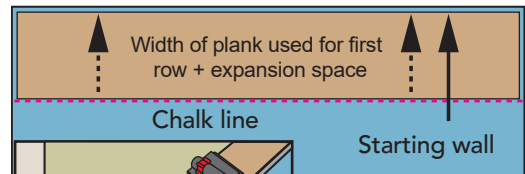

## STEP 3.

Use spacers to maintain the recommended expansion gap between the flooring and the walls. Place spacers adjacent to each plank joint and at the beginning and end of each row. This will lock-in assembled panels and prevent shifting during installation.

It is important to have your starting row perfectly straight and properly supported against your starting wall. Always allow a 1/2" gap around all other fixed objects including upright pipes or other fixtures.

**Tip:** Scrap flooring (cut up in short strips) may be used for additional spacing material.

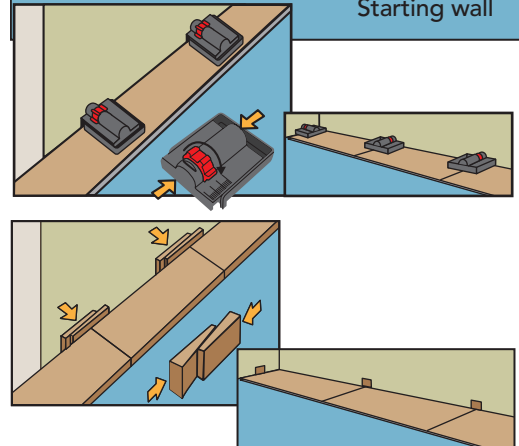

## STEP 4. THE FIRST ROW

Install planks from left to right.

A.

B. Install the second plank in the first row by inserting the short side tongue at a slight angle into the first planks short side groove..

C. Press the second plank down flat. Ensure that the end-to-end joint is firm.

**NOTE:**

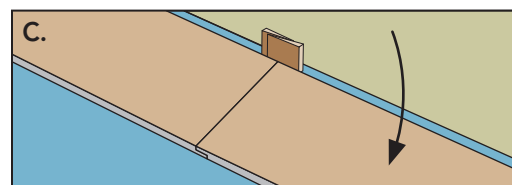
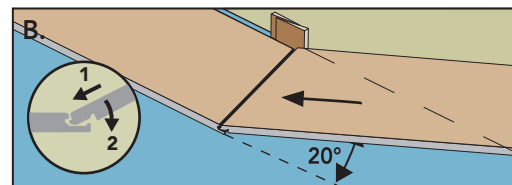
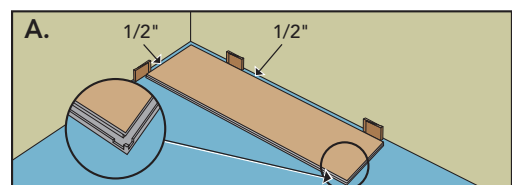

### STEP 5. SECOND & CONSECUTIVE ROWS

The following method is designed to make the installation easier and also protect the short edge from damage.

Confirm the first row is straight with working line. Start the second row with a cut plank at least 8" long. If not, cut a new starter plank for this row (Do not use a full plank!).

- A. Angle the first plank at a 20° angle and insert the long side tongue into the groove edge of the first row. Lower the plank down until it rests on shim.
- B. Insert the short end of the second plank into the short end of the first plank as shown, offset the planks by about 1/8". Lower plank (hinge down) to rest on shim. Gently slide the second plank forward into the long groove in the first row. Working left to right, remove shims sequentially and lower plank to the floor.
- C.
  1. Join the ends, offset by 1/8"
  2. Slide plank #2 forward into first row groove

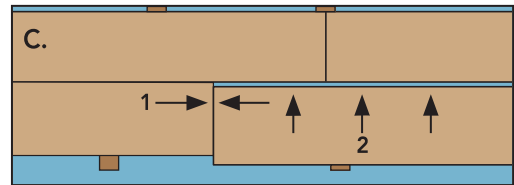
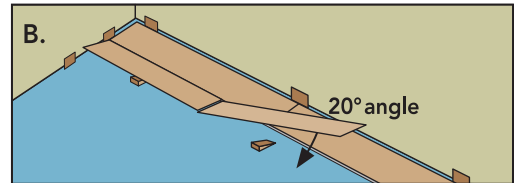
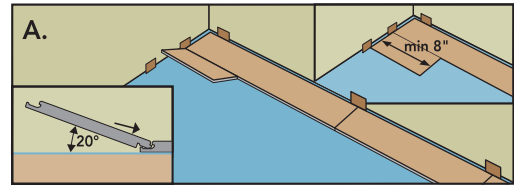

#### INSTALLERS TIP:

To reduce friction apply beeswax or similar to the "end-joint" locking systems. Repeat this process with each plank until you reach the end of the row.

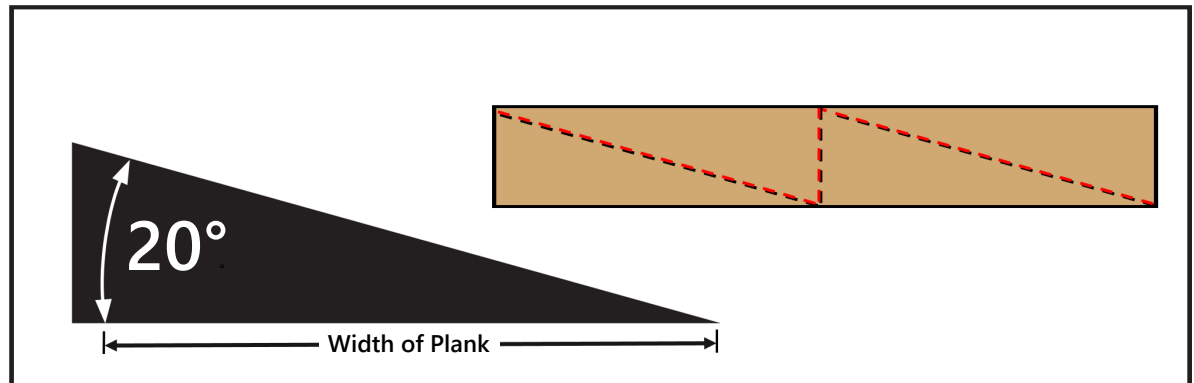

### STEP 6. IMPORTANT:

When laying out planks, always stagger end joints from row to row, by at least 12" to ensure the structural integrity of your floor and a pleasing appearance. Work from different cartons of planks to minimize clustering of patterns. Pay close attention to avoid "stairstep" or "H-patterns" appearing in the flooring.

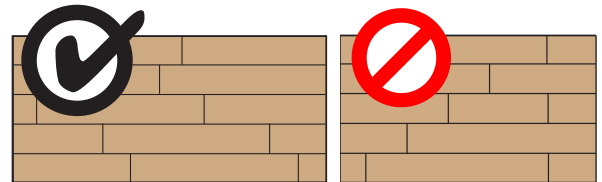

### STEP 7. CUTTING END-OF-ROW BOARDS:

**IMPORTANT:** The last board in each row must be cut to fit, while still maintaining a proper expansion gap at the walls. Here's how:

- A. Flip the plank over, end-to-end.
- B. Lay the flipped board next to the row of planks, and mark it.
- C. Cut the plank at the mark maintaining a proper expansion gap at the walls.
- D. Flip the plank back over and install as normal.

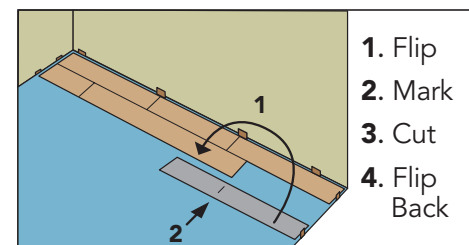

# This material cuts easily using a sharp utility knife, Just Score & Snap!

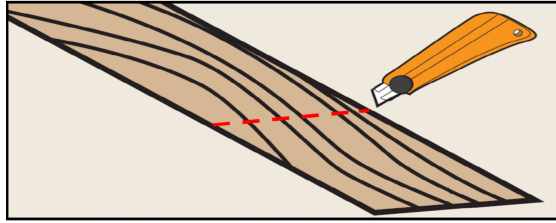

Floor cutters\*, power miter saw, table, circular and jig saws can also be used to cut this flooring product.

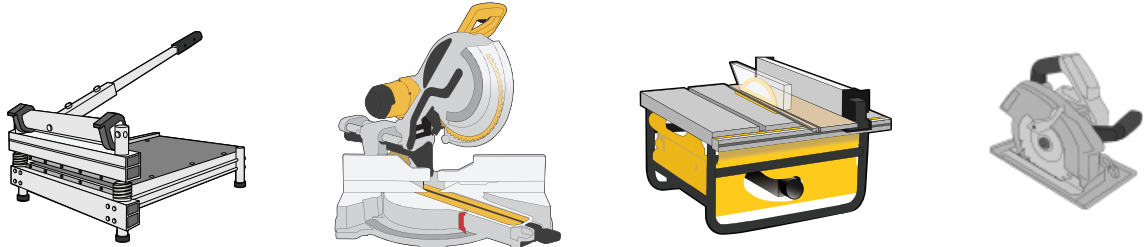

\*Maximum cutting Width = 9".

## STEP 8.

When you are unable to angle panels to install them (under door jams, toe kicks, radiators etc.), shave off the locking edge lip in the groove by using a sharp chisel or razor knife. Apply a thin even bead of flexible (Gel Control) super glue or hot-melt glue (for plastics) along the modified groove as shown.

\*These adhesives dry quickly so pre-fit and position plank prior to applying glue.

Clean excess off immediately !

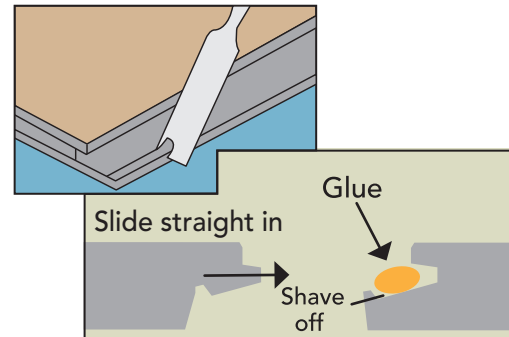

## STEP 9.

The last row will need to be cut lengthwise to fit properly. Here's how to get it just right:

- Lay a plank right on top of the last full row in place.
- Then lay another plank of flooring on top of that plank, with the tongue side touching the wall.
- Use plank B as a straight-edge guide, and mark a line lengthwise on plank A.
- Cut plank A lengthwise on line.
- Plank A can now be installed as the last row. We recommend you use edge glue for this last row.

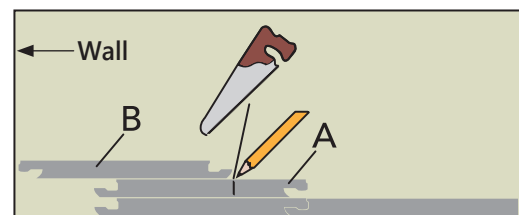

## FITTING AROUND IRREGULAR SHAPED OBJECTS:

Make a template to fit around pipes or irregular shaped objects. Place the pattern upon the plank and trace. Cut along the trace lines using a jig saw, and install plank.

Note: Be sure to leave the recommended expansion space around all fixed objects, cabinetry and metal door jambs.

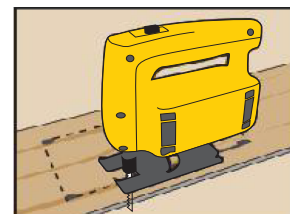

### PIPES:

When a pipe is passing through the floor make a hole on the plank 1" greater than the diameter of the pipe, cut the plank with a 45° angle towards the hole. The cut-off piece edges are glued in the position again. *Do not glue to the subfloor.*



When there is single pipe on a wall, you can plan to have the end-joints meet at pipe, drill and install as shown.

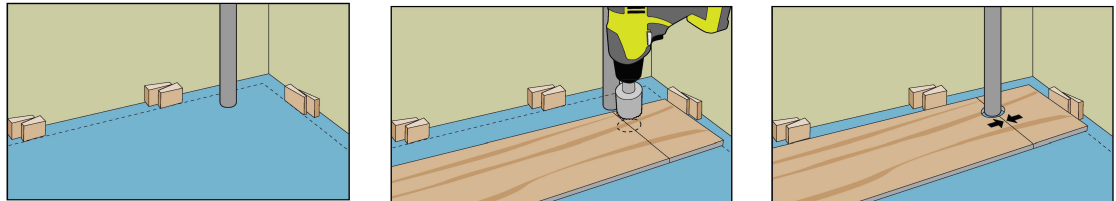

If there are multiple or larger pipes passing through the floor make hole(s) on the plank 1" greater than the diameter of the pipe, cut the plank with a 45° angle towards the hole. The cut-off piece edges are glued in the position again. *Do not glue to the subfloor.*

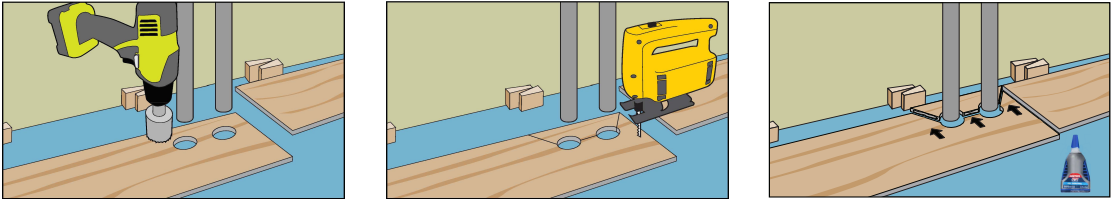

### STEP 10.

To ensure the floor is able to "float" freely, be sure to affix baseboards or moldings to the walls, not to the floors. This way, the floor can expand & contract within the gap. Also, never nail the first or last rows directly down to the subfloor! This option is not appropriate for floating floors!

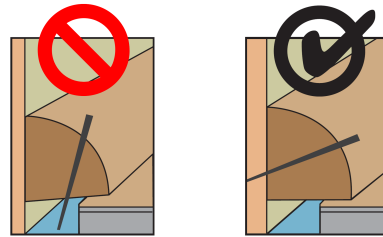

### STEP 11.

In areas where your new floor meets other types of flooring, such as carpet or tile, select an appropriate molding to get a professional looking and safe transition.

**U-Track** is attached to the substrate to secure the End Cap, T-Molding and Reducer transitions.

**End Cap** moldings transition from new floor to carpet, sliding doors, raised hearths, etc.

**Reducer** moldings transition from new floors to hard surfaces that are lower than the floor, such as vinyl or tile.

**Stair Nose** moldings are used when the new floor edge is at a step-down; Example: when the flooring meets at the top of a stairway "going down".

**T-Moldings** cover expansion spaces at doorways, and they transition from your new floor to other hard surfaces of similar height.

**Quarter Round** moldings are used to cover expansion spaces between the baseboards and the flooring.

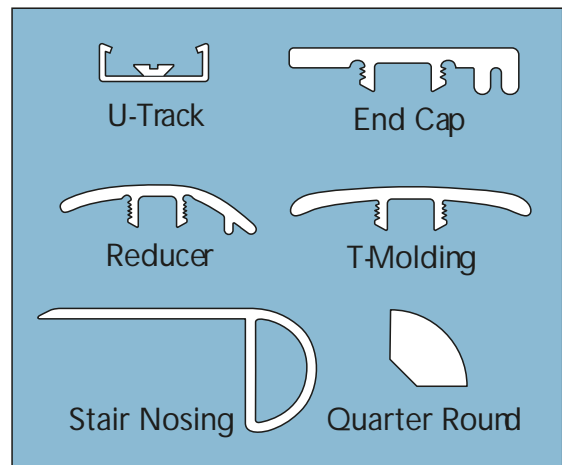

### REPAIRS:

Save extra planks from the initial order in the event that installed planks become damaged and repairs are needed. This will ensure lot number and shading compatibility.

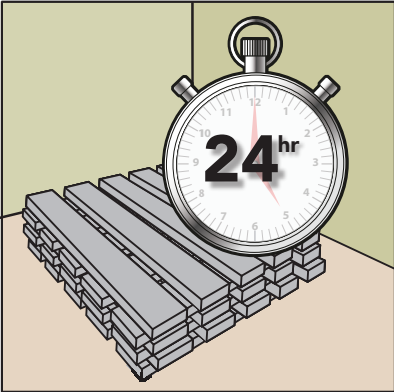

# GLUE DOWN \* [QUICK CLICK Method Click Here](#)

**Save time & avoid frustration! Please read these entire instructions before starting your installation, and A.I.M. for success!**

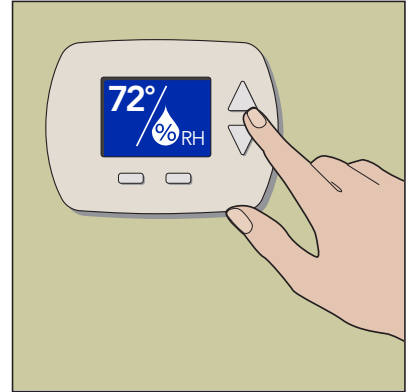
AIM	AIM	AIM
		
<p><b>Acclimate Completely</b>  <b>ACCLIMATION:</b> Not required if flooring and the jobsite are between 60°F – 80°F, otherwise acclimate for 24 hours between 60°F – 80°F.</p>	<p><b>Install Correctly</b>            Take time to review LL Flooring's installation guidelines to ensure that your installation goes well from beginning to end.</p>	<p><b>Maintain Environment</b>            After installation, maintain your flooring between the temperature ranges of 60°F – 80°F.</p>

**?** **Need Help?** To obtain installation assistance or product information concerning this flooring, contact the store of original purchase, or call the LL Flooring's customer care at 800-366-4204.

**!** **WARNING! DO NOT SAND, DRY SWEEP, DRY SCRAPE, DRILL, SAW, BEADBLAST OR MECHANICALLY CHIP OR PULVERIZE EXISTING RESILIENT FLOORING, BACKING, LINING FELT, ASPHALTIC "CUTBACK" ADHESIVES OR OTHER ADHESIVES.** These products may contain asbestos fibers and/or crystalline silica. Avoid creating dust. Inhalation of such dust is a cancer and respiratory tract hazard. Smoking by individuals exposed to asbestos fibers greatly increases the risk of serious bodily harm. Unless positively certain that the product to be removed is a non-asbestos containing material, you must presume it contains asbestos. Regulations may require that the material be tested to determine asbestos content. See current edition of the Resilient Floor Covering Institute (RFCI) publication, "Recommended Work Practices for Removal of Resilient Floor Coverings" for detailed information and instructions on removing all resilient covering structures. For current information, go to [www.rfci.com](http://www.rfci.com).

**!** **LEAD WARNING:** Some paints and finishes in homes built before 1978 may contain lead. Exposure to excessive amounts of lead dust presents a health hazard. Prior to removing or sanding, comply with all applicable federal, state, and local laws, and reference the publication "Lead-Based Paint: Guidelines for Hazard Identification and Abatement in Public and Indian Housing" available from the United States Department of Housing and Urban Development regarding (1) appropriate methods for identifying lead-based paint and removing such paint; and (2) any licensing, certification, and training requirements for persons performing lead abatement work.

**!** **MOLD AND MILDEW WARNING:** Prior to removing an existing resilient floor or when installing a new floor, if there are visible indications of mold or mildew or the presence of a strong musty odor in the installation area, the source of the problem should be identified and corrected before proceeding with the flooring work. Excessive moisture in the subfloor could promote mold, mildew, and other moisture related issues like the trapping of moisture emissions under the flooring, which may contribute to an unhealthy indoor environment. Mold has the potential to cause health problems and may produce allergens, irritants, and in some cases, potentially toxic substances. Before installing the new resilient flooring, ensure the underlayment and/or subfloor is allowed to thoroughly dry and that any residual effect of excessive moisture, mold, or structural damage has been corrected. Remediation measures may require structural repairs such as replacing the contaminated underlayment and/or subfloor, cleanup measures using appropriate protection and biocide, or hiring a professional mold and mildew remediation contractor. Consult EPA mold guidelines on EPA's website at <https://www.epa.gov/mold>

**!** **WARNING:** Drilling, sawing, sanding or machining wood products can expose you to wood dust, a substance known to the State of California to cause cancer. Avoid inhaling wood dust or use a dust mask or other safeguards for personal protection. For more information go to [www.P65Warnings.ca.gov/wood](http://www.P65Warnings.ca.gov/wood)

## RECOMMENDED USE:

- Residential and commercial\* interior use only. \*See products Limited Residential / Commercial Warranty for details.
- Do not install in wet areas like patios and showers, or exterior areas. Do not install in boats or other moving vehicles.

## GRADE:

On, above and below Grade.

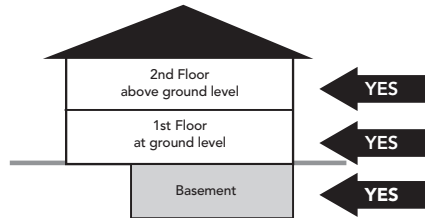

## JOBSITE CONDITIONS:

- The building should be enclosed with all doors and windows in place.
- Prior to delivery and install: All wet works (e.g. drywall taping, texture, painting, stucco etc.) should be complete and allowed to dry. The rooms should be at normal "lived-in" conditions with HVAC operational for at least one week prior to the installation when building is so equipped.
- When installing over basements and garages, ensure they are dry and well ventilated.
- Crawlspace must be dry with a minimum 18" from the bottom of the floor joist to the ground, Crawl space earth (or thin concrete slab) should be covered 100 percent by a vapor retarder of black polyethylene (minimum 6 mil) or any recommended puncture-resistant membrane, such as Class C, meeting ASTM D1745. Ventilation shall be per local building codes.
- To avoid damages to the floor's finish, all construction activity should be completed before installing this floor.
- All gutters should be in place and functioning properly. Yard grading should be sloped to run water away from the home foundation.
- Ensure that exterior doors and appliances have sufficient clearance to accommodate the new flooring. Do not undercut metal door jambs before first confirming it doesn't violate local building and fire codes.
- The installer - not the manufacturer or retailer - is responsible for making sure that the site conditions are appropriate prior to installation of this floor.

## USER / OWNER / INSTALLER RESPONSIBILITIES:

- Install in good lighting.
- Product installation constitutes acceptance. Visually inspect the product and determine acceptability before installation. Claims will not be accepted regarding visual defects after flooring has been installed. If any planks are unacceptable due to color, finish, milling or any other reason, it is your responsibility to determine to use them, hide them in areas like closets, trim off the imperfection, or not install them at all.
- A reasonable amount of installed flooring (up to 25% or 100 sq. ft. whichever is less) is enough to determine acceptance of quality.
- Retain a box label and keep on file with your receipt for future reference.
- If quality issues are suspected stop the installation and call your local store or CUSTOMER CARE at 1-800-366-4204.

## HELPFUL TOOLS: (as needed)

- Tape Measure • Pencil • Chalk line • 6' level • Framing square/Metal straight edge • Screed • Utility knife (blades)
- Miter saw • Table saw • 60 tooth carbide tip saw blades • Jamb saw • Drill • Drill bit set • Hammer • Flat pry bar • Broom
- Eye protection • Ear protection • Knee pads • Niosh dust mask • Gloves • Hygrometer (to measure /monitor in-home humidity) • Moisture meter • Color putty • Touch up markers • Speed square

## ACCLIMATION: 24 hours

This product requires no acclimation if its temperature and the jobsite are between 60°F and 80°F.

If a method is not available for testing temperature of the flooring (e.g. an infrared Thermometer Temperature gun), or flooring is outside of this range, allow the flooring to acclimate for 24 hours at the approved temperature.

- Stack boxes flat, and no more than eight cartons high in areas to receive new flooring.

## TEMPERATURE:

After installation maintain your flooring between the temperature ranges of 60°F – 80°F.

## RELATIVE HUMIDITY:

No limits.

## CUTTING ALLOWANCE:

A 10' x 10' room has net 100 square feet (Sq. Ft.) – the actual area that will have flooring – but more product is required to allow for cutting which generates unusable pieces.

Carefully measure the net square feet required, adding up multiple areas.

The table gives an approximate recommendation for cutting allowance:

Quantities are always rounded up to the nearest box.

**Tip:** If more than half a box is not available for spares we recommend ordering an extra box.

**Please note:** Actual cutting waste may be lower or higher based on room layout. E.g. multiple rooms vs. one large area and "pattern" being installed. E.g. diagonal installations will require more cutting allowance.

Consider carefully before returning boxes.

Keeping extra boxes is a great idea and inexpensive insurance against damage, if a repair is needed the product and batch will be the same, and you have options even if the product has been discontinued.

Diagonal installations will generally require 5% more material over and above the cutting allowance given above.

Net Area SqFt	Total with Cutting Allowance SqFt	% Applied
100	110	10
200	218	9
400	432	8
600	642	7
800	848	6
1000	1050	5
above 1000 SqFt add 5%		

## EXPANSION SPACE:

A minimum gap of 1/2" is required between the flooring and all vertical obstructions (walls, door jambs, pipes, staircases, posts, fixtures, built-ins, etc.).

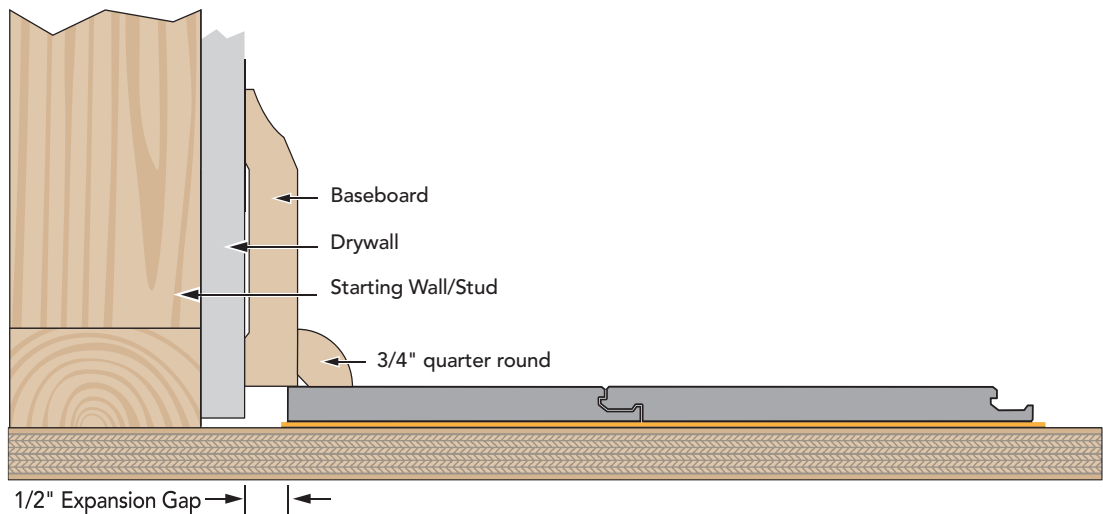

TYPICAL INSTALLATION

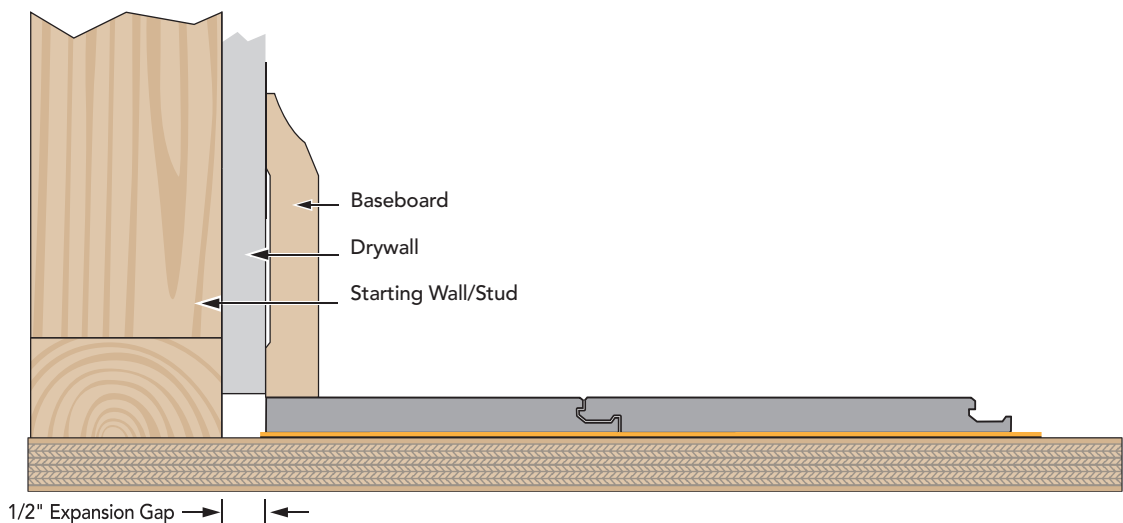

How to achieve required Expansion Gap using base board only

If the room has electric baseboard heaters, leave a minimum of 3/4" between the surface of the flooring and the bottom of the heaters, allowing heat to circulate properly.

**NOTE:** Gapping and buckling can develop if expansion space and contraction overlay requirements are not followed.

### **CABINETS / FIXED FIXTURES:**

Although not recommended, cabinets may be installed on top of this product (see the product's limited warranty for details).

### **SUNLIGHT:**

Your flooring may change color with prolonged exposure to sunlight. Use of window coverings, shades, or tinting your windows, is recommended to slow this process

### **WOOD SUBFLOORS NEED TO BE: CLEAN – FLAT – DRY:**

Wood substrates must be structurally sound and free from movement or deflection.

#### **CLEAN:**

Free from contaminants including but not limited to: oil, grease, parting compounds, chemical contaminants, sealing and curing agents, paint, drywall compound, old adhesives such as cutback, solvents, and loose or broken patching agents and other foreign materials that might prevent adhesive bond (refer to the adhesive technical data sheet / install guide).

Free from particles including but not limited to: dust, dirt, and grit.

#### **SUBFLOOR MUST BE FLAT AND SMOOTH**

#### **FLAT:**

Subfloors must be flat within 1/8" over 6' and 3/16" over 10' and smooth, abrupt peaks and valleys must be avoided. Correct any issues.

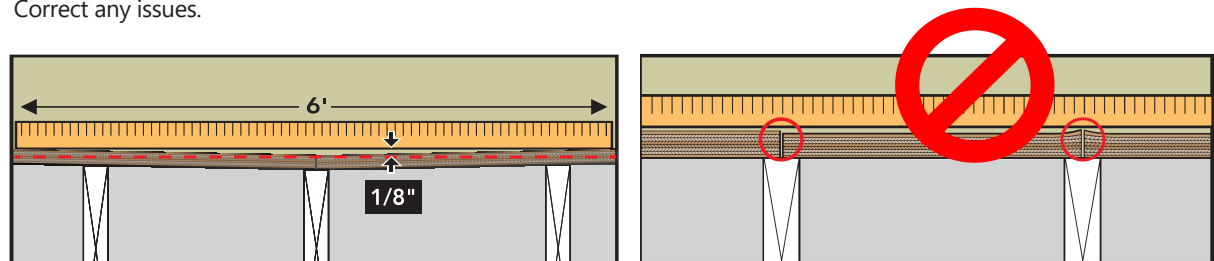

Improper substrate or flatness can result in gaps, locking mechanism failure and premature wear on surface.

#### **DRY:**

Follow product use limitations and adhesive manufacturers technical data sheets (TDS) / install guide.

Do not install this flooring over plywood underlayment attached to concrete, unless it is known that an appropriate moisture barrier has been installed (all applications).

### **WOOD SUBFLOOR PREPARATION:**

- Screw down loose or squeaky sections of plywood and replace areas that are damaged.
- To address flatness concerns sand or plane high spots, 30 lb. roofing felt can be used to build up (in layers) low areas on wood subfloors.
- Substrates that are un-level due to structural deficiencies should be repaired by a licensed contractor.
- **Never apply plastic sheet over wood subfloors.**

#### **STRUCTURAL REQUIREMENTS:**

Note that joist spacing determines minimum subfloor thickness.

##### **Joist spacing 16" on center (OC) or less**

– Plywood: Minimum of (5/8", 19/32") Oriented Strand Board (OSB): minimum (3/4", 23/32")

Advantech minimum (3/4", 23/32")

##### **Joist spacing 16" up to 19.2" (OC)**

– Plywood: Minimum of (3/4", 23/32") Oriented Strand Board (OSB): minimum of (3/4", 23/32")

##### **Joist spacing over 19.2" up to maximum 24" (OC)**

– Plywood: Minimum of (7/8") Oriented Strand Board (OSB): Minimum of (1") or two layers of subflooring or brace between truss/joists in accordance with local building codes.



## MOISTURE TESTING:

Use a meter that is species / material adjustable. E.g. Ligno-scanner SDM or mini-Ligno DX/C moisture meter.

- If using alternate meter check that meter can be used with the subfloor material in question.  
Test sub-floor in multiple locations, with an appropriate wood moisture meter, it's recommended to test 20 location per 1000 square feet and average the results. Moisture readings must not exceed 12%.
- Higher readings indicate a moisture concern that needs to be addressed before installation can begin.
- For future reference, documenting and saving the test results is recommended.

## CONCRETE SUBFLOORS NEED TO BE: CLEAN – FLAT – DRY:

Concrete must be structurally sound and free from movement or deflection.

### CLEAN:

Free from contaminants including but not limited to: oil, grease, parting compounds, chemical contaminants, sealing and curing agents, paint, drywall compound, old adhesives such as cutback, solvents, and loose or broken patching agents and other foreign materials that might prevent adhesive bond (refer to the adhesive technical data sheet / install guide).  
Free from particles including but not limited to: dust, dirt, and grit.

### SUBFLOOR MUST BE FLAT AND SMOOTH

#### FLAT:

Subfloors must be flat within 1/8" over 6' and 3/16" over 10' and smooth, abrupt peaks and valleys must be avoided.

Improper substrate or flatness can result in gaps, locking mechanism failure and premature wear on surface.

Correct any issues.

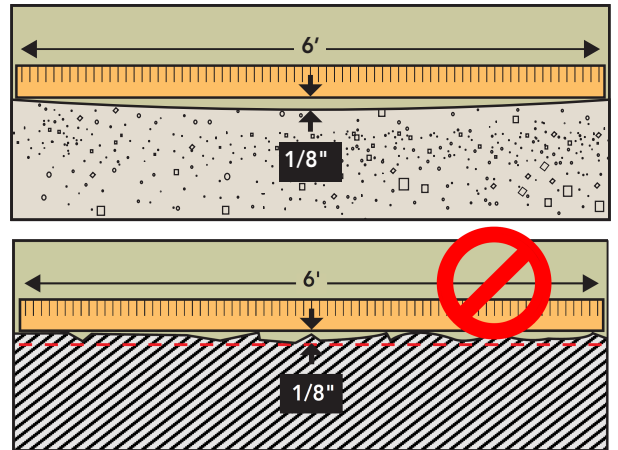

#### DRY:

Follow product use limitations and adhesive manufacturers technical data sheets (TDS) / install guide.

Do not install this flooring over plywood underlayment attached to concrete, unless it is known that an appropriate moisture barrier has been installed (all applications).

## CONCRETE SUBFLOOR PREPARATION:

Prepare and test per ASTM F 710; The Standard Practice for Preparing Concrete to Receive Resilient Flooring. Surface cracks, grooves, depressions and other irregularities shall be filled or smoothed with latex cement patching compound. Patching or underlayment compound shall be moisture, mildew and alkali-resistant and provide a minimum of 3000 psi compressive strength after 28 days.

To address flatness concerns; Grind down\* high spots and fill in low spots with an appropriate Portland cement based patch or self-leveler (allow to cure fully) prior to installing floor. **\*CAUTION: Follow OSHA guidelines (29 CFR 1926.1153) regarding silica dust hazards.**

Do not glue directly over unsuitable substrates such as but not limited to; adhesive residue, exterior grade plywood, OSB, strip hardwood flooring, chemically treated wood, particle board, chipboard, flakeboard, fiber or cement board, masonite, pressboard, gypcrete or gypsum base products.

Do not install this flooring over expansion joints, crack isolation joints, or other moving joints in concrete slabs. Flooring material shall be cut to either side of the joint and a suitable transition installed.

Surface Contaminants: Mechanically remove all surface contaminants by grinding or scarifying the substrate.

**CAUTION:** Follow OSHA guidelines (29 CFR 1926.1153) regarding silica dust hazards.

Slab temperature- must be between 65°F and 85°F.

Installing over existing flooring- see adhesive manufacturer's recommendations\*.

Bond tests should always be performed\*.

It is the installers responsibility to moisture test all concrete substrates regardless of age or grade level to determine the acceptable limits of moisture applicable to the adhesive used\*.

Follow manufacturer's TDS / installation guide.

### MOISTURE TESTING:

Perform moisture tests regardless of age or grade of the concrete to determine moisture levels. A concrete slab shall be cured a minimum of 60 - 90 days before performing moisture tests. If concrete moisture levels exceed the adhesive manufacturer acceptable limits, do not install the floor.

Follow the moisture testing instructions, product limitations and procedural guidelines in the adhesive manufacturer's Technical Data Sheets / Manufacturer Guidelines. The test requirements and limits that apply will vary by product specified.

There are only two accepted moisture test methods.

- 1 The Standard Test Method for Determining Relative Humidity in Concrete Floor Slabs Using in situ Probes (ASTM F 2170)
  - 2 The Standard Test Method for Measuring Moisture Vapor Emission Rate of Concrete Subfloor Using Anhydrous Calcium Chloride (ASTM 1869).
- Note: The use of moisture meters, / plastic sheet tests are not industry accepted quantitative test methods
  - For your protection, documenting and saving the test results is recommended.
  - Slabs must be free of hydrostatic pressure.

### LIGHTWEIGHT ALTERNATIVE SUBFLOORS:

Use over gypsum-based/underlayments is limited to dry, "above-grade" installations where the gypsum has dried hard (not dusty / powdery), with a minimum compressive strength > 2,500 psi. Please refer to adhesive / sealer manufacturer recommendations.

### RECOMMENDED ADHESIVE:

[Bostik LOCK A499](#) Pressure Sensitive Adhesive may be used on slabs with elevated moisture up to 99% RH [ASTM F2170] - MVER - 12 lbs [ASTM F1869] and a pH level of pH - up to 12

[Bostik LOCK A699](#) Pressure Sensitive Adhesive may be used on slabs with elevated moisture up to 99% RH [ASTM F2170] - MVER - 12 lbs [ASTM F1869] and a pH level of pH - up to 12

[Bostik LOCK A799](#) Transitional may be used on slabs with elevated moisture up to 99% RH [ASTM F2170] - MVER - 12 lbs [ASTM F1869] and a pH level of pH - up to 12

Please review manufacturer's technical data sheet for more details.

### RECOMMENDED PATCHES / LEVELERS:

- Cement Patching- Bostik WebcreteR 95™
- Total Surface Self-Leveling- Bostik SL-175™ (plus Primer Pro) Follow manufacturer's TDS / installation guide.

### EXISTING FLOORS:

- This flooring can only be glued down to existing flooring that is properly prepped and approved by the adhesive manufacturer.
- Do not install over wood flooring installed over concrete unless it is known that an appropriate moisture barrier has been installed over the concrete.
- Do not install over cushioned vinyl flooring, or existing floating floor products.
- Do not install over carpet and padding.
- To prevent telegraphing a suitable embossing compound may be needed to conceal grout lines and heavily textured tiles. To prevent telegraphing a suitable embossing compound may be needed to conceal grout lines and heavily textured tiles

### RADIANT HEAT:

- This flooring is suitable for glue down installation over Hydronic Radiant heating systems provided that the heating element is not in direct contact with the product.
- New heating systems should be running two weeks before installation to remove residual moisture from the subfloor.
- Lower temperature of heating system to 60°F for one week prior to installation.
- Gradually increase temperature in increments of 10° per day to avoid "shock" to resilient flooring.
- Surface temperature should not exceed or sustain 85°F.
- Because of the wide array of systems on the market each with its own features and applications, it is recommended that the user consult with the heating provider for best practices and installation methods.
- It is the user's responsibility to confirm the suitability of any selected or existing radiant-heating system that will be used in conjunction with this flooring.
- Rugs placed over radiant heated flooring can increase the surface temperature in that area by 3°- 5°F

### ADDITIONAL NOTES:

When moving furniture and heavy equipment, use luan board, plywood, or other similar covering to protect the floor.

**Each project is unique and different. Installation advice or recommendations are given as a courtesy and not intended to take the place of an installer's visual inspection, expertise or informed judgment, the end user / contractor on-site is ultimately responsible for ensuring that selected products are appropriate for local conditions and / or their final use of the product.**

# Glue Down Method of Quick Click Flooring

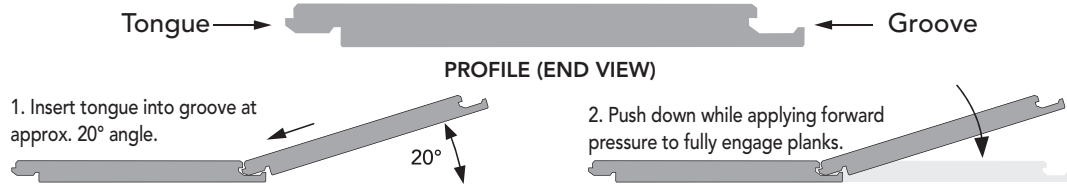

NOTE: Tongue image is for illustration only. The actual locking shape of your floor may differ.

Cut off the tongues on the first row of planks. Be sure locking system is fully engaged! Planks must be flat in relation to each other (on all sides) without gaps before continuing install.



**NEVER USE A TAPPING BLOCK OR PULL BAR. THESE WILL DAMAGE YOUR FLOORING AND VOID THE WARRANTY**

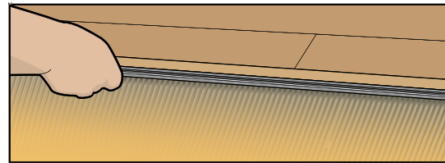

## GETTING STARTED:

Remove any existing quarter round, shoe moldings, baseboards and doorway transitions.

Remove existing floor covering as required, check floor flatness per details on previous page and address any issues. Check that all doors will swing open with adequate clearance over the new flooring prior to starting any work.

**Important: Do not cut metal door frames before first confirming it does not violate local building and fire codes. Any metal doors must be addressed by a specialist to adjust.**

Undercut all door casings and jambs with a jamb saw to allow the flooring to slide under the doorjamb. If a baseboard is still in place, extend the undercut about 1" beyond the door frame casing. To find the height to cut the jamb, lay a scrap piece of flooring next to the door frame and lay the saw blade on top. After cut, ensure the floor does not bind, always leave 1/16" clearance under the door jamb / casing for the floor to be able to move freely without vertical restriction. **Check for alarm or other low voltage wiring before cutting.** Ensure that appliances have proper clearance to accommodate the new flooring.

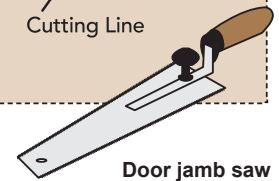
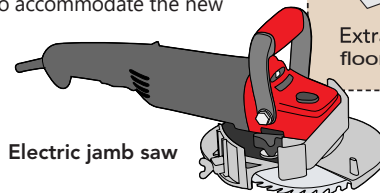
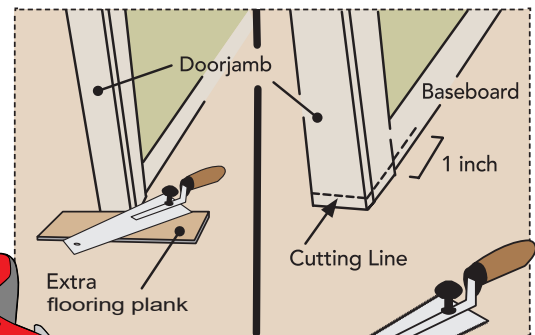

Check that subfloor is flat to within specifications per details found under "CLEAN-DRY-FLAT" in previous section. **Correct any issues.**

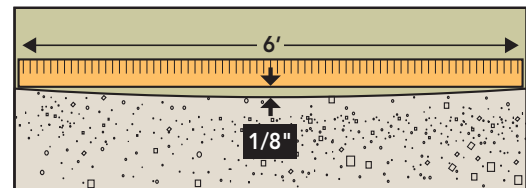

### STEP 1. LAYOUT:

Determine which direction the planks will be installed. Generally, plank flooring is run parallel with the longest straight exterior wall, or the focal point of the room. Considerations are fireplaces, doors, cabinets, transitions.

For best appearance full planks are desirable at the focal point and most cases it is the longest unbroken wall in the room.

Determine which direction the planks will be installed.

Installers: It is advisable to determine the installation layout and direction (North/South vs East/West) with the end user.

**IMPORTANT: Mix materials from several cartons to ensure best overall color/shade appearance of the installed floor.**

#### Preparation of planks for the starting row when needed:

To avoid very narrow pieces at finish wall; measure the distance between the starting wall to the finish wall, then divide this number by the width of the flooring planks.

The fraction is the width of the last plank.

#### Eg. for a 10' room:

Start – Finish = 120" – 1" (1/2" expansion x 2) = 119"

Width of Plank = 5"

$119 \div 5 = 23.8$

Twenty three full planks are required and last will be fraction x plank width  
 $5" \times 0.8 = 4"$

If width of last plank is less than 2.5", balance by cutting (Rip) starting row of planks accordingly.

**NOTE:** If a narrow strip is unavoidable for the last row, the final two rows can be glued together at the joint using a thin even bead of flexible (Gel Control) super glue or hot-melt glue (for plastics) at the long seams to avoid board separation.

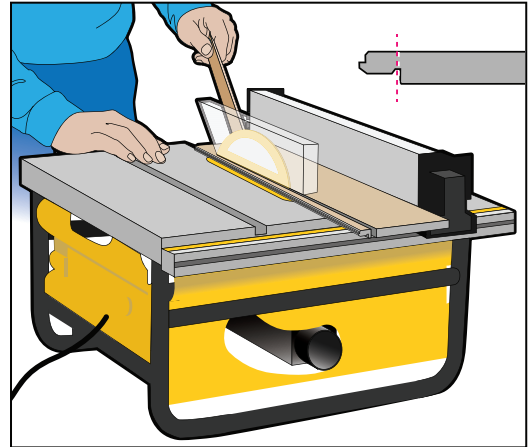

### STEP 2: ESTABLISH A WORKING LINE

In at least two places, measure out equal distance from your starting wall, 12"–18" from each corner.

The distance from the starter wall to the line will be the width of the plank used on first row, the expansion space. Mark these points and snap a chalk line (as shown) parallel to your starting wall. Be sure to maintain proper gap around all vertical obstructions, e.g. newel posts, raised hearths, upright pipes, etc.

### STEP 3.

Use spacers to maintain the recommended expansion gap between the flooring and the walls. Place spacers adjacent to each plank joint and at the beginning and end of each row. This will lock-in assembled panels and prevent shifting during installation.

It is important to have your starting row perfectly straight and properly supported against your starting wall. Always allow a 1/2" gap around all other fixed

objects including upright pipes or other fixtures.

**Tip:** Scrap flooring (cut up in short strips) may be used for additional spacing material.

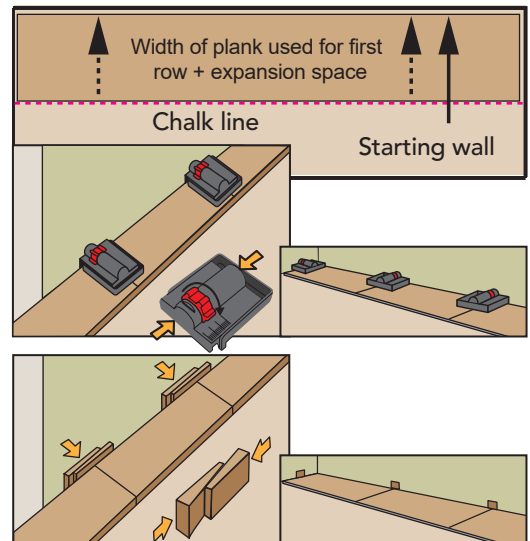

### STEP 4. ADHESIVE:

Below are some examples of adhesive application please refer to individual adhesive's Technical Data Sheet for more details.

- Spread adhesive evenly with the proper trowel as described in manufacturers guidelines Eg. 1/16" x 1/16" x 1/16" Square Notch Trowel. Open time is influenced by substrate porosity and atmospheric conditions (i.e. temperature, humidity, and air movement).
- Use of a laser or other method to ensure starting row is straight and care taken to ensure accurately placed is highly recommended before pressure is applied to the floor.

**Pressure Sensitive Adhesive (PSA)** (porous and non-porous substrates)

- Wait 30-60 minutes after adhesive is spread to allow it to dry (adhesive will darken to visually cue installer).
- Working time is approximately 12 hours under acceptable temperature and humidity conditions.

**Semi-wet set** (porous substrates only)

- Wait 20-30 minutes after adhesive is spread to allow it to skin over.
- Working time is approximately 20-30 minutes under acceptable temperature and humidity conditions.
- Roll and cross roll floor with a 75-100 lbs (34-45 kg) roller at the end of the installation to ensure proper transfer of adhesive.

**NOTE:** Depending on layout/pattern installed, only apply adhesive enough adhesive that you can comfortably "reach and lay" into (typically 2' - 3').

**NOTE:** Pressure sensitive adhesives have a "high grab" feature; take care to place planks accurately as they will not slide into place once laid into the glue.

### STEP 5. STARTING ROW:

Install planks from left to right, up against the spacers.

- Lay the first plank against the wall, and up to the left wall. The groove edge should be facing toward you.
- Align and overlap end-joint of second plank. Place the second plank in the row next to the first plank, assemble the end joints by lowering (overlapping) the left plank over the right plank as shown until locked in.
- Lower the plank "straight" down, be sure joint is even and flat.

Continue laying the first row until you reach the other wall.

Note: Do not apply pressure or set plank into adhesive prior to being positioned properly.  
Installers tip: Use plastic spacer (wedge) or similar to temporarily prevent full contact with pressure sensitive adhesives. After board is positioned pressure may be applied.

**NOTE:** See STEP 8. for how to cut the last plank in row.

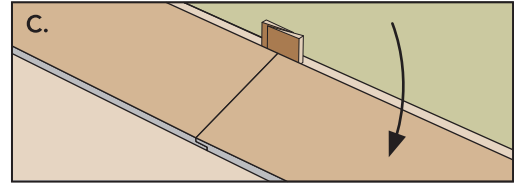
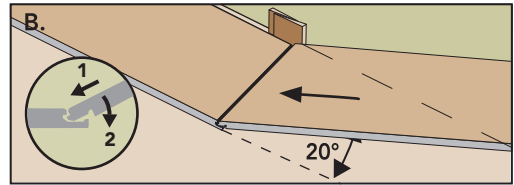
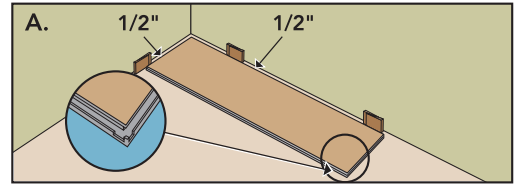

### STEP 6. SECOND & CONSECUTIVE ROWS:

Use shims to keep planks at the recommended 20° angle off the subfloor. This makes it easier to install the next plank in row. Confirm the first row is straight with working line.

Start the second row with a cut plank at least 8" long. If not, cut a new starter plank for this row (Do not use a full plank!).

- Angle the first plank at a 20° angle and insert the long side tongue into the groove edge of the first row. Lower the plank down until it rests on shim.
- Insert the short end of the second plank into the short end of the first plank as shown, offset the planks by about 1/8". Lower plank (hinge down) to rest on shim. Gently slide the second plank forward into the long groove in the first row. Working left to right, remove shims sequentially and lower plank to the floor.
- Join the ends, offset by 1/8"
  - Slide plank #2 forward into first row groove

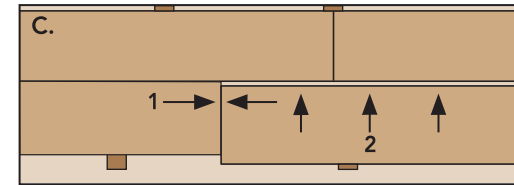
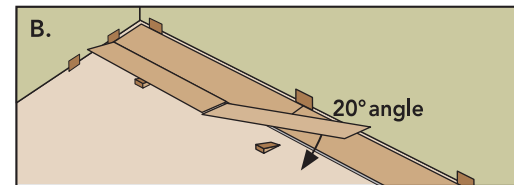
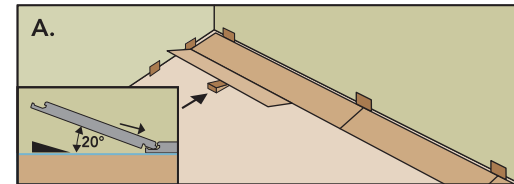

### INSTALLERS TIP:

To reduce friction apply beeswax or similar to the "end-joint" locking systems. Repeat this process with each plank until you reach the end of the row.

Here is a basic example of how to create four of your own shims from from standard 2" x 4" stock material:

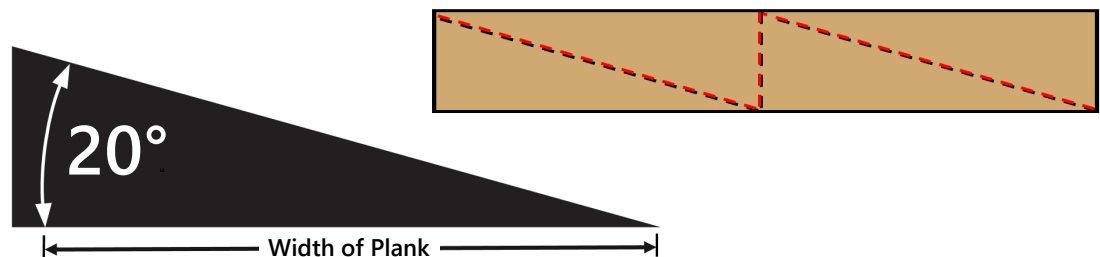

To reduce friction apply beeswax or similar may be used to lubricate the "end-joint" locking systems. Repeat this process with each plank until you reach the of each row.

### STEP 7. IMPORTANT:

When laying out planks, always stagger end joints from row to row, by at least 12" to ensure the structural integrity of your floor and a pleasing appearance. Work from different cartons of planks to minimize clustering of patterns. Pay close attention to avoid "stairstep" or "H-patterns" appearing in the flooring.

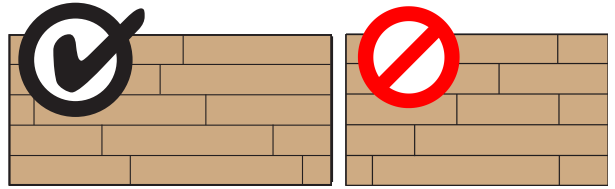

### STEP 8. CUTTING END-OF-ROW BOARDS:

**IMPORTANT:** The last board in each row must be cut to fit, while still maintaining a proper expansion gap at the walls. Here's how:

- Flip the plank over, end-to-end.
- Lay the flipped board next to the row of planks, and mark it.
- Cut the plank at the mark maintaining a proper expansion gap at the walls.
- Flip the plank back over and install as normal.

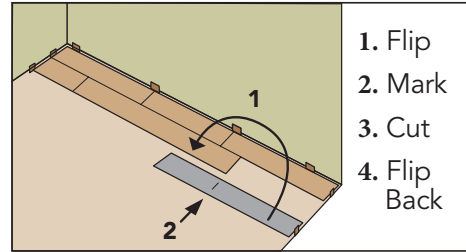

This material can be cut using a sharp utility knife & straight edge. Just Score and Snap!

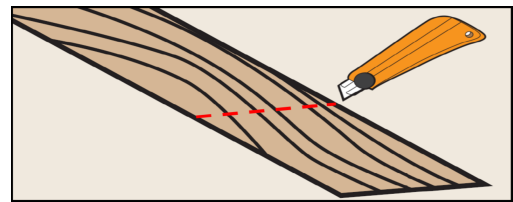

Floor cutters\*, power miter, table, circular and jig saws can also be used to cut this flooring product.

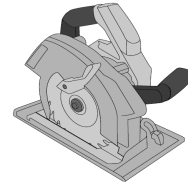
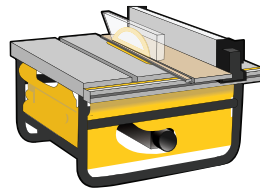
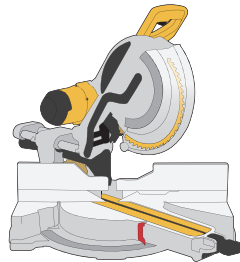
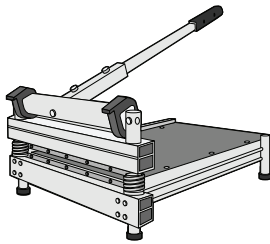

\* Cutting Width: 9" Max.

### STEP 9.

When you are unable to angle panels to install them (under door jams, toe kicks, radiators etc.), shave off the locking edge lip in the groove by using a wood chisel or plane. Position the plank under the obstacle, then slide the plank gently into place, and tighten with the use of a pull bar and tap hammer.

TIP: Use painter's tape across the joint to keep it tight until the glue sets.

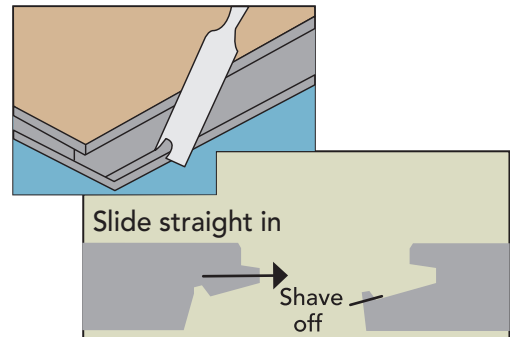

### STEP 10.

The last row will need to be cut lengthwise to fit properly. Here's how to get it just right:

- Lay a plank of flooring right on top of the last full row in place.
- Then lay another plank of flooring on top of that plank, with the tongue side touching the wall.
- Use plank B as a straight-edge guide, and mark a line lengthwise on plank A.
- Cut plank A lengthwise along this line.
- Plank A can now be installed as the last row. We recommend you use edge glue for this last row.

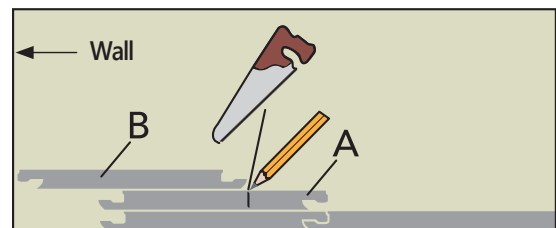

**FITTING AROUND IRREGULAR SHAPED OBJECTS:** Make a template to fit around pipes or irregular shaped objects. Place the pattern upon the plank and trace. Cut along the trace lines using a jig saw, and install plank. Note: Be sure to leave the recommended expansion space around all fixed objects, cabinetry and metal door jambs.

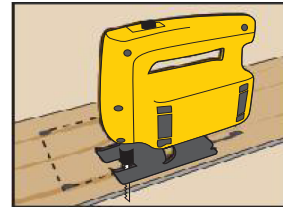

**PIPES:**

When a pipe is passing through the floor make a hole on the plank 1" greater than the diameter of the pipe, cut the plank with a 45° angle towards the hole. The cut-off piece edges are glued in the position again.



When there is single pipe on a wall, you can plan to have the end-joints meet at pipe, drill and install as shown.

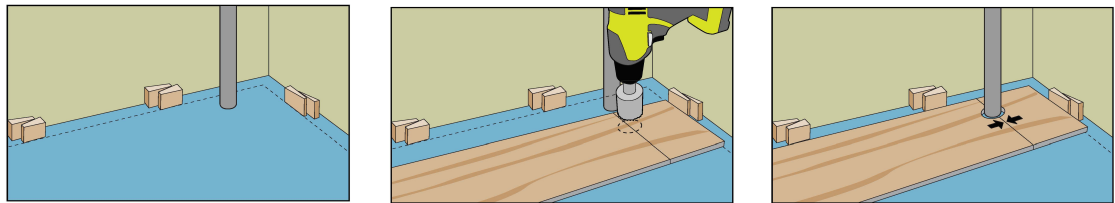

If there are multiple or larger pipes passing through the floor make hole(s) on the plank 1" greater than the diameter of the pipes, cut the plank with a 45° angle towards the hole. The cut-off pieces are glued into position. Glue pieces together and engage with adhesive on subfloor for added stability.

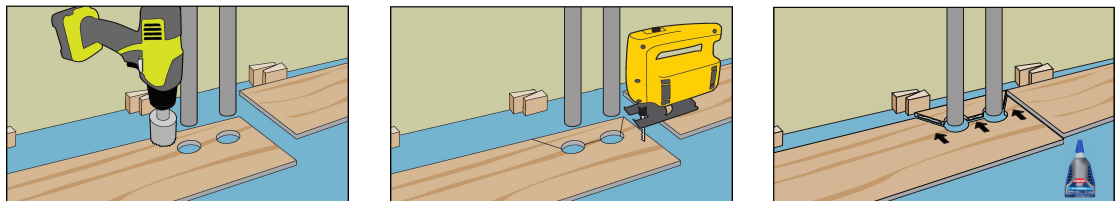

**STEP 11.**

Be sure to affix baseboards or moldings to the walls and not to the floors.

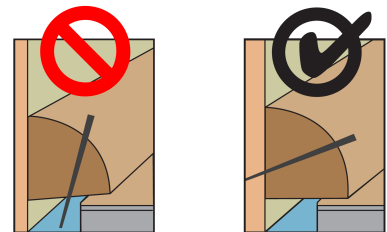

## STEP 12

In areas where your new floor meets other types of flooring, such as carpet or tile, select an appropriate molding to get a professional looking and safe transition.

**U-Track** is attached to the substrate to secure the End Cap, T-Molding and Reducer transitions.

**End Cap** moldings transition from new floor to carpet, sliding doors, raised hearths, etc.

**Reducer** moldings transition from new floors to hard surfaces that are lower than the floor, such as vinyl or tile.

**Stair Nose** moldings are used when the new floor edge is at a step-down; Example: when the flooring meets at the top of a stairway "going down".

**T-Moldings** cover expansion spaces at doorways, and they transition from your new floor to other hard surfaces of similar height.

**Quarter Round** moldings are used to cover expansion spaces between the baseboards and the flooring.

**REPAIRS:** Save extra planks from the initial order in the event that installed planks become damaged and repairs are needed. This will ensure lot number and shading compatibility.

## TRAFFIC:

Refer to adhesive manufacturers recommendations regarding cure times, foot traffic, heavy traffic or rolling loads.

### Precautionary Note:

Do Not wet mop the floor for 1 week after the install is complete.

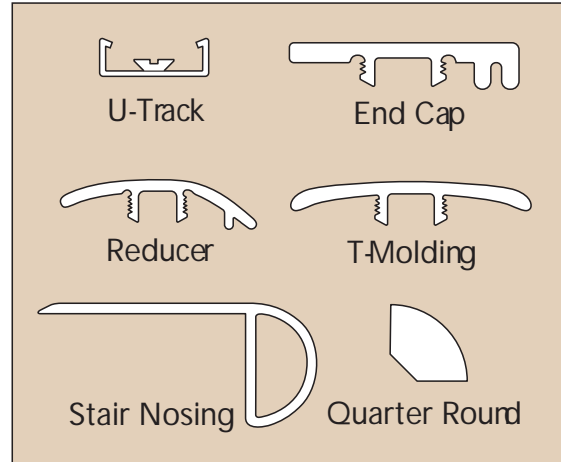



# CARE AND MAINTENANCE GUIDE

CORELUXE is designed to bring beautiful wood and stone looks to your environment to fit your flooring needs and style, while also providing a solution with easy maintenance.

Created for residential and commercial applications, this flooring is tough but still requires care and attention to keep it looking beautiful for years to come.

- For day to day cleaning we recommend the floor to be swept and/or vacuumed. The vacuum head must be a felt brush type. Do not use vacuum with beater bars / very hard bristles. This will eliminate fine particles of dirt and grit that act like sandpaper which will scratch and / or dull the surface of your flooring.
- Reduce the visibility of minor scratches using Bellawood Scratch Away.
- Minimize abrasive material and dirt by placing mats on both sides of exterior doors and by using area rugs in high-traffic areas.
- Use Bellawood Floor Cleaner to deep clean your whole floor and clean spots and soiled areas.
- DO NOT use cleaning agents containing wax, oil or polish. Leftover residue will form a dull film.
- DO NOT use steel wool or scouring pad, as they will scratch the floor.

The use of residential steam mops on this product is allowed. Use at lowest power with a suitable soft pad, do not hold a steam mop on one spot for an extended period of time.

Refer to the steam mop's manufacture instructions for proper usage.

Occasional wet or jet mopping is allowed.

**This flooring can be dented, gouged and scratched, this can be caused by but is not limited to: dropped objects, damaged shoe heels / soles, pet nails /claws, toys, abrasive particles, etc.**

**The following steps will help reduce the risk of this kind of damage:**

- Floor protectors should always be installed to the bottom of furniture to prevent scratching and marking.
- Minimize abrasive material and dirt by placing mats on both sides of exterior doors and by using area rugs in high-traffic areas.
- We recommend the use of a hard surface (non-studded), non-rubber chair mat to protect your floor from office chairs with casters.
- Light, rolling furniture should be outfitted with broad-surface, non-staining casters that have been engineered for hard surface floors (casters should be a minimum of 1" wide and at least 2" in diameter).
- Never slide or roll heavy furniture or appliances across the floor.
- If flooring will be exposed to rolling traffic or heavy, appliances protect the flooring with plywood or hard-board panels.
- Remove shoes that are damaged exposing sharp metal, have cleats etc. before walking on the floor.

Your flooring is like other products and is susceptible to fading, with prolonged exposure to sunlight. Use of window coverings, shades or tinting your windows is recommended.

Although the flooring planks are waterproof, you should promptly remove spills using a soft cloth reducing slip hazards.

**We love our pets but occasionally accidents happen.**

- Cleaning the affected area should begin immediately upon discovery:
- Use absorbent paper tissue to collect as much of the deposited material as possible and properly dispose of it. Remove any existing residue with a suitable disinfecting cleaner.
- Repeat until all residue is removed. Buff dry. Clean, using Bellawood Floor Cleaner.
- The more time that elapses before removal, the more difficult a stain will be to remove.
- Keep pets' nails trimmed.

We recommend the use of NON-RUBBER backed mats that are labeled "colorfast" by the manufacturer.

Non-staining, vinyl-backed mats or woven rugs should be used at all door entries from outside to avoid discoloration from asphalt driveways, catch dirt, grit, sand, and other debris to help sustain the flooring.

We also recommend using protective mats around sinks and tubs to catch excess water and debris.

# LIMITED COMMERCIAL WARRANTY

## Corelux RVP Products

*For Residential Limited Warranty [click here](#)*

### 1. WHO MAY USE THIS LIMITED WARRANTY?

LL Flooring, Inc. (“we,” “us,” and “our”) extends this limited warranty only to the customer who originally purchased the product (“you” and “your”). It does not extend to any subsequent owner or other transferee of the product. **THIS LIMITED WARRANTY IS NOT TRANSFERABLE. THE LIMITED WARRANTY EXTENDS ONLY TO THE ORIGINAL PURCHASER.**

### 2. LIGHT AND HEAVY COMMERCIAL USES AND THE PERIOD OF COVERAGE

- *Light Commercial*

Our products are designed for commercial and business uses. The limited warranty periods for each product are determined by their application and use. Light commercial uses are defined as areas where foot traffic is light to moderate and light to moderate castor chair use where castors are modified using caster chair wheels (soft wide castors specifically for hard surface) or castor chairs are used with castor chair mats designed for hard surface and without the use of heavy chemicals, acids, greases, or other such contaminants. Examples of light commercial uses include: professional offices, including lobbies, waiting rooms, hallways; corporate locations such as banks, conference rooms, meeting rooms; small retail stores such as salons, jewelry stores, dressing rooms; applications in apartment lobbies and common areas, and connecting hallways and offices.

- *Heavy Commercial*

Heavy (or Full) Commercial Areas are areas of use with floors subjected to, moderate to heavy foot traffic and moderate to heavy castor chair use where modified caster chair wheels (soft wide castors specifically for hard surface) or castor chairs are used with castor chair mats, designed for hard surface moderate to heavy traffic. Portable furnishings with casters, rests and hard wheels that concentrate the weight or point loading of the appliance/equipment are excessive heavy use.

- *Determination of Application and Use*

We shall have the sole right to make the determination of whether an application is for light or heavy commercial uses. For purposes of such determination, we may need to visit the location that relates to the limited warranty claim for inspection and use. **These limited warranties do not apply to excessive heavy use or industrial uses. Industrial uses include but are not limited to use in environments with heavy chemicals, acids, greases (including for food) or other such contaminants, and those use in environments with forklift use, industrial plants, uses where extra heavy static and dynamic loads are applied to flooring, and use of casters bearing extra heavy loads on resilient flooring.**

Subject to the requirements listed in Section 5 below, this limited warranty starts on the date of your purchase and lasts for the time period set forth in the chart below for your specific product (the “Limited Warranty Period”):

<b>Commercial</b>		
<b>Product Identification</b>	<b>Light Commercial Limited Warranty Period</b>	<b>Heavy Commercial Limited Warranty Period</b>
<b>Corelux Premier</b>	<b>20 Year Warranty</b>	<b>10 Year Warranty</b>
<b>Corelux Signature</b>	<b>15 Year Warranty</b>	<b>5 Year Warranty</b>
<b>Renature by Corelux</b>	<b>15 Year Warranty</b>	<b>5 Year Warranty</b>
<b>Corelux Essentials</b>	<b>10 Year Warranty</b>	<b>No Warranty</b>

If, for any reason, we repair or replace the product, the Limited Warranty Period is not extended. We may change the availability and period of this limited warranty at our discretion, but any changes will not be retroactive, and shall only apply to products purchased after such changes.

### **3. WHAT DOES THIS LIMITED WARRANTY COVER?**

During the Limited Warranty Period (defined above) and subject to the complete terms of this limited warranty, this limited warranty covers the following product aspects from defects in materials and workmanship of the purchased product (the “product”):

- *Limited Finish Wear Warranty.* Finish wear from normal use conditions resulting in the exposure of the decorative layer, subject to the exclusions provided in Section 4 below.
- *Product Structure.* The product will be free of manufactured defects in materials and workmanship.
- *Curling.* Vinyl peel and stick will be free from edge curling from normal use conditions.
- *Limited Waterproof Warranty.* The structural integrity of the product will not be significantly diminished by exposure to water during the limited Warranty Period under normal use conditions. This limited warranty extends only to topical moisture and topical water exposure. Please note that this limited warranty relates only to the purchased product itself and does not warrant that your subfloor, or any other items or properties will be safe from water damage because of the installation of this product.
- *Limited Pet Stain Warranty.* While the vomit, urine, and feces are still wet (and such wetness is not exceeding twenty-four hours), the product will resist staining and damage caused by the vomit, urine, and feces of domestic cats and dogs that occur during normal use, subject to timely attention under the Installation and Care Requirements (defined and discussed below). Please note that this limited warranty relates only to the purchased product itself and does not warrant that your subfloor, or any other items or properties will be safe or resistant from these pet stains because of the installation of this product.
- *Delamination.* The product will not delaminate under normal use conditions.

#### **4. WHAT DOES THIS LIMITED WARRANTY NOT COVER?**

This limited warranty does not cover any defects or damages due to: (a) failure to strictly follow the Installation and Care Requirements (defined and discussed below) regardless of the installer; (b) transportation; (c) storage; (d) improper use; (e) modifications; (f) unauthorized repair; or (g) external causes such as accidents, abuse, or other actions or events beyond our reasonable control. In addition, this limited warranty does not cover any defects or damages due to the following:

- *Excessive Moisture.* Non-structural damages caused by moisture (such as mildew and mold) are excluded. In addition, moisture intrusions from concrete hydrostatic pressure, flooding, or plumbing leaks, along with high levels of alkalinity, can affect surrounding structure, walls, subfloor, fixtures, furniture, underlayment, moldings, trims, subfloor heating elements, or anything that is not the product. Damage from such conditions, including to the floor and subfloor, is not covered under this limited warranty.
- *Moisture Protection.* This flooring should not be used to seal an existing floor from moisture. This flooring cannot prevent problems associated with, or caused by flooding, excessive moisture, existing moisture, or alkalis in the subfloor or conditions arising from hydrostatic pressure. To be abundantly clear, this limited warranty does not cover damage to surrounding structure, walls, subfloor, fixtures, furniture, underlayment, moldings, trims, subfloor heating elements, or anything that is not the product itself. This limited warranty does not cover damage resulting from mold and/or mildew growth due to prolonged exposure to moisture, all casualty events involving water coming in contact with your floor and failures normally covered by insurance, including, but not limited to, damages caused by flooding or standing water from leaky pipes, faucets, or household appliances.
- *Site and Environmental Conditions.* Defects or damages resulting from: site conditions (such as extreme heat, radiant heat (for some products), or exposure to sand); indentations and scratches (caused by furniture, heavy rolling loads like un-modified wheels on caster chairs, castor chairs without protection mats, heavy electric wheel chairs, metal or thin wheels on appliances, tools, grit, heels, pet nails and claws, toys, etc.); improper maintenance and accidents; misuse and abuse. These items are not covered under this limited warranty
- *Heat Exposure.* This flooring is susceptible to changes in the conditions to which it is exposed including seasonal and environmental factors. Gapping or buckling due to expansion and contraction in extreme temperatures may occur.
- *Gloss Reduction.* Fading or loss of gloss (or glaze) is not finish wear and not a product defect covered under this limited warranty.
- *Other Finishes.* This limited warranty covers the factory-applied finish only. Applying another finish or sanding (such as in preparation for another finish) may damage the factory-applied finish and voids this limited warranty against finish wear.

- *Exterior/Outdoor Installations/Use.* This limited warranty does not cover exterior, outdoor, partial outdoor installations / use of the product.
- *Non-Flooring Installations.* Except where the product's Installation and Care Requirements designate the product as appropriate for wall installation, this limited warranty does not cover use of the products for installations on ceilings or other usages for purposes other than flooring (like furniture or countertops).
- *Visible Defects.* As discussed further below in Section 5.C., products installed with visible defects are not covered under this limited warranty. Accordingly, before installation, you and the installer should examine each product to ensure it is satisfactory.
- *Color and Shade Variations.* New or replacement flooring may not always match samples, printed color photography (including websites and catalogs), existing flooring or other products (such as cabinets, stair railings, trim and moldings). These variations should be expected. Inspect product before installation claims for color and shade variation will not be accepted after the product is installed.
- *Discoloration/Fading from Mats.* This limited warranty does not cover discoloration due to use of rubber-backed mats or other incompatible mats.
- *Fading.* This limited warranty does not cover fading from exposure to sunlight
- *Odd Lots or As-Is.* An odd lot is flooring that is discounted and sold "As-Is" because it did not pass our rigorous inspection process. As such, odd lot product is not covered by this limited warranty.
- *Third-Party Purchases.* Except for an authorized transfer in writing by us, this limited warranty does not cover any purchases other than those made directly from LL Flooring in store, online, or by phone.
- *Radiant Heat.* Please consult the Installation and Care Requirements regarding whether your particular product may be installed over radiant heat. If you Installation and Care Requirements do not include materials regarding installation over radiant heat, your product is not appropriate for installation over radiant heat and not covered under this limited warranty for such installations. If your Installation and Care Requirements provide instructions for such installation, this limited warranty does not cover those products that are not installed according to the radiant heat manufacturer guidelines or not installed in compliance with the Installation and Care Requirements.
- *Removal and Replacement.* This limited warranty does not cover the cost of the removal or replacement of Countertops, cabinets, built-in appliances or other fixtures, installed on top of your floor.
- *Improper Installation and Maintenance.* This limited warranty does not cover any dissatisfaction or damage due to improper installation or maintenance (but excluding

improper installation or maintenance performed by us). This includes any damages caused by any installation (regardless of the source of the installation advice other than directly provided by us) that conflicts with the applicable product installation instructions—for example, damage caused by sub-surface, sub-flooring and jobsite environmental deficiencies, improper transportation, acclimation and storage.

## **5. HOW DO I MAINTAIN THIS LIMITED WARRANTY DURING THE WARRANTY PERIOD?**

To maintain this limited warranty during the Limited Warranty Period, you are obligated to meet all of the following requirements for your use, installation, and maintenance of the product (the “Installation and Care Requirements”). The Installation and Care Requirements must be strictly followed for the limited warranty to remain valid and not be void.

- A. *Follow the Pre-Installation Requirements.* Prior to installing a single board, tile, or product, you or the installer must determine that the job-site environment and the sub-surfaces (including subfloor substrate) meet or exceed applicable industry and product standards, including, without limitation, moisture testing and controls. The product installation instructions discuss these standards and are provided in full below. These requirements must be strictly followed.
- B. *Comply with All Laws.* In your installation, maintenance, and use of the product you must comply with all laws and regulations, including, without limitation, all applicable environmental and building codes, regulations, and laws.
- C. *Inspect All Products for Visible Defects.* Products installed with visible defects are not covered under this limited warranty. Accordingly, before installation, you and the installer should examine each product to ensure it is satisfactory. If any products are unacceptable for any reason, it is up to you to determine to use them, trim off the imperfection, or not install them at all. You should plan on being present during your installation to ensure that all required procedures are completed and products with visible defects are not installed. It is important to inspect individual boards and tiles and to frequently step back to observe the “whole picture” before installation is completed. *If quality issues are suspected before or during installation immediately contact the store where your floor was purchased or call us at 1-800-366-4204.*
- D. *Follow the Installation and Care Instructions.* It is your duty to make sure the installation requirements are strictly followed, including, without limitation, as they relate to the use of moisture barriers, installation tools, and the evaluation of job site conditions and moisture testing. The product’s installation and care manual(s) are provided in this document below, and those terms and provisions are part of this limited warranty.

## **6. WHAT ARE YOUR REMEDIES UNDER THIS LIMITED WARRANTY?**

With respect to any defective product during the Limited Warranty Period, we will provide a LL Flooring store credit in the amount of the purchase price paid for the defective portion of the flooring (excluding any installation costs and labor). A store credit is the sole remedy under this warranty and can be used for store product purchases only. Provided, however, we reserve the right, in our sole discretion, to repair or replace such product (or the defective part) free of charge in lieu of a store credit. We will also pay for shipping and handling fees to return the repaired or replacement product to you if we elect to repair or replace the defective product.

This limited warranty applies to the colors, designs, and products available at the time of repair or replacement. If the original flooring is not available, LL Flooring will work with you to substitute a product of similar value. LL Flooring will always try to consider your needs.

We reserve the right to investigate, assess, and validate reported claims by, among other things, requesting samples from you for technical analysis and performing an inspection of the flooring and installation location.

## **7. HOW DO YOU OBTAIN LIMITED WARRANTY SERVICE?**

To file a warranty claim during the Limited Warranty Period, you may:

- A. Visit the store where you purchased your floor;
- B. Call us at 1-800-366-4204; or
- C. Email via the “contact us” link at [www.LLFlooring.com](http://www.LLFlooring.com).

Claims must be submitted within the Limited Warranty Period and within ninety (90) days of the date that the problem with the floor is first discovered. No warranty claim will be serviced without contacting us through one of the methods listed above and providing accurate and complete information in a timely manner.

## **8. WHAT ARE THE LIMITATIONS OF LIABILITY?**

**THE REMEDIES DESCRIBED ABOVE IN SECTION 6 ARE YOUR SOLE AND EXCLUSIVE REMEDIES AND OUR ENTIRE LIABILITY FOR ANY BREACH OF THIS LIMITED WARRANTY. NOTWITHSTANDING ANY OTHER PROVISION OR TERM, OR THIS LIMITED WARRANTY OUR LIABILITY SHALL UNDER NO CIRCUMSTANCES EXCEED THE ACTUAL AMOUNT PAID BY YOU FOR THE DEFECTIVE PRODUCT OR DEFECTIVE PORTION THEREOF.**

**UNDER NO CIRCUMSTANCES SHALL WE BE LIABLE FOR ANY CONSEQUENTIAL, INCIDENTAL, SPECIAL OR PUNITIVE DAMAGES OR LOSSES, WHETHER DIRECT OR INDIRECT. WITHOUT LIMITING THE FORGOING SENTENCE, LOSSES, DAMAGES OR EXPENSES RELATING TO ANYTHING OTHER**

**THAN THE FLOOR ITSELF ARE NOT COVERED, INCLUDING, WITHOUT LIMITATION, DAMAGES DUE TO ANY DELAYS, LOST PROFITS, LOSS OF BUSINESS, LOSS OF USE OF PREMISES, MISSED TIME FROM WORK, HOTEL STAYS, STORAGE FEES, KENNEL COSTS FOR PETS, REMOVAL OF DEFECTIVE FLOORING, INSTALLATION OF REPLACEMENT FLOORING, OR REMOVAL OR REPLACEMENT OF ITEMS BUILT ON TOP OF ANY FLOORING (FOR EXAMPLE, COUNTERTOPS, CABINETS, BUILT-IN APPLIANCES).**

## **9. TERMS OF DISPUTE RESOLUTION**

**NO JOINT OR CLASS ACTIONS:** Neither you nor LL Flooring shall be entitled to join or consolidate claims in arbitration by or against other customers of LL Flooring with respect to other accounts, bring mass, class action, or consolidated claims in arbitration or a court of competent jurisdiction, or arbitrate or litigate any claim as a representative or individual of a class or in a private attorney general capacity. The arbitrator may not consolidate more than one person's claims and may not otherwise preside over any form of a representative or class proceeding.

**ARBITRATION:** The following informal dispute resolution procedure is available to you if you believe that we have not performed our obligations under this limited warranty. You must use this informal procedure before pursuing any legal remedy in the courts.

LL Flooring and you agree to attempt to resolve any disputes amicably. If, after thirty (30) days we are unable to do so, then you and LL Flooring each agree that any claim or controversy of any sort relating to our agreement, the Products or these limited warranty terms shall be determined by arbitration in the nearest U.S. city to the LL Flooring store where you purchased the products, before one arbitrator. At the option of the first to commence an arbitration, the arbitration shall be administered either by JAMS pursuant to its Streamlined Arbitration Rules and Procedures, or by the American Arbitration Association pursuant to its Commercial Arbitration Rules. The arbitrator shall have no power to add to, delete from or modify these limited warranty terms. Each of us shall have the right to conduct discovery to which we would be entitled had the dispute been resolved in a state court of general jurisdiction in the state of the LL Flooring store where you purchased the products. Judgment on the arbitrator's award may be entered in any court having jurisdiction. This clause shall not preclude either party from seeking provisional remedies in aid of arbitration from a court of appropriate jurisdiction. The arbitrator may, as part of the award, allocate all or part of the costs of the arbitration, including the fees of the arbitrator and the reasonable attorneys' fees of the prevailing party. The arbitrator shall only have the authority to resolve individual disputes between you and LL Flooring. Notwithstanding the foregoing, in addition to our rights set forth above, we may initiate proceedings directly in the appropriate court located in the U.S. city nearest the LL Flooring store where you purchased the products in connection with any claim to collect amounts due and owing by you.

## **10. NO OTHER TERMS**

**SAMPLES, DESCRIPTIONS, AND OTHER INFORMATION CONCERNING THE PRODUCT CONTAINED IN CATALOGS, ADVERTISEMENTS, OR OTHER PROMOTIONAL MATERIAL OR STATEMENTS MADE BY SALES**



**REPRESENTATIVES OR DISTRIBUTORS ARE FOR GENERAL INFORMATIONAL PURPOSES ONLY AND ARE NOT BINDING UPON LL FLOORING. NO SALES REPRESENTATIVES, STORE MANAGERS, ACCOUNT REPRESENTATIVES, OR DISTRIBUTORS SHALL HAVE ANY AUTHORITY WHATSOEVER TO ESTABLISH, EXPAND OR OTHERWISE MODIFY LL FLOORING' WARRANTIES. THE TERMS OF THIS LIMITED WARRANTY DOCUMENT MAY NOT BE AMENDED EXCEPT THROUGH A WRITTEN AGREEMENT TITLED "AMENDMENT TO LIMITED WARRANTY" AND SIGNED BY AN AUTHORIZED OFFICER OF LL FLOORING, PROVIDED, HOWEVER, THAT LL FLOORING MAY GENERALLY MODIFY, CANCEL, UPDATE, OR OTHERWISE CHANGE ITS PROSPECTIVE WARRANTIES FOR FUTURE SALES AT ANY TIME AND FOR ANY REASON.**

## **11. OTHER PROVISIONS**

The section headings provided in this limited warranty are for convenience and informational reference only and shall not affect the interpretation or construction of this limited warranty.

THE PROVISIONS OF THIS LIMITED WARRANTY ARE DEEMED TO BE SEVERABLE AND THE INVALIDITY OR UNENFORCEABILITY OF ONE PROVISION SHALL NOT AFFECT THE VALIDITY OR ENFORCEABILITY OF ANY OTHER PROVISION.

## **12. ADDRESS FOR LL FLOORING**

LL Flooring, Inc. is located at 4901 Bakers Mill Lane, Richmond, VA 23230.

[HOME](#)